

ASBESTOS AIR SAMPLING TECHNICIAN CERTIFICATION

U.S. ENVIRONMENTAL PROTECTION AGENCY
NEW YORK STATE DEPARTMENT OF HEALTH
ACCREDITED ASBESTOS TRAINING PROVIDER

STUDENT MANUAL



ENVIRONMENTAL EDUCATION ASSOCIATES

888 4 ENV EDU *environmentaleducation.com*



ENVIRONMENTAL EDUCATION ASSOCIATES

working to make our communities healthy

EPANYS ASBESTOS SAMPLING TECHNICIAN COURSE

TABLE OF CONTENTS

Section 1	History and Uses of Asbestos
Section 2	Identification & Characterization of Asbestos
Section 3	Health Effects Associated with Asbestos Exposure
Section 4	Overview of Current Federal, State and Local Laws/Regulations Concerning Asbestos
Section 5	Personal Protective Equipment
Section 6	Decontamination Systems
Section 7	Personal Hygiene Practices
Section 8	Preparation of an Asbestos Abatement Work Site
Section 9	Engineering Control Technologies
Section 10	Asbestos Abatement Clean-up and Disposal Procedures
Section 11	General Safety Considerations
Section 12	Principles and Practices of Asbestos Air Monitoring and Sample Analysis
Appendix A	Glossary

SECTION 1

HISTORY AND USE OF ASBESTOS

INTRODUCTION

Asbestos: The Magic Mineral

Asbestos is not man-made; it is a naturally occurring mineral, which is mined out of the earth in much the same way as coal. It is a generic term referring to a group of minerals possessing a unique blend of inorganic chemicals and fibrous crystalline structures. For hundreds of years, it was regarded as “the magic mineral” due to its amazing properties and versatility of use and has yet to be replaced with material of comparable qualities.

Specific attributes and characteristics vary to some degree with the different types, but the commercial value, in general, rests with its high tensile strength, good thermal and electrical insulating properties, and moderate to good chemical resistance. Because of these qualities, some 36 million metric tons were used worldwide in well over 3000 products between the years 1900 and 1980.

THE HISTORIC TIME LINE

Ancient civilizations, such as the Egyptians, Greeks and Romans are known to have used asbestos mainly because of its fire-resistant properties (see Table 1-1). It was used in such things as curtains, tablecloths, cremation shrouds, blacksmith gloves for forging weapons and lamp wicks. In fact, that’s how the mineral got its name. The Greeks, marveled by the fact that their lamp wicks were not consumed by the flames, called the material “Sasbestos” which translates to “unquenchable” or “inextinguishable”. The Romans named it “amianthus”, meaning “incorruptible”.

It was used in ancient pottery and later by the Chinese as a component of gunpowder. In writings from the Ninth Century A.D., Charles the Great (Charlemagne) was reported to have cleaned his woven asbestos tablecloth by tossing it into a fire. Several other civilizations actually believed that asbestos had medicinal properties.

Mining/Manufacturing Operations

It wasn’t until the late 1800’s that asbestos was used commercially in the United States. In the 1930’s, asbestos became one of the most popular construction materials in the United States (the largest consumer of this mineral in the world). The most important use of asbestos was a fireproofing material. Some of the many products containing asbestos are summarized in Table 1-2.

Asbestos usage soared in 1941 with the coming of World War II. Thousands of workers were hired by the shipyards to meet the demand for the vast fleets of both cargo and military vessels. The working conditions were often less than adequate and rarely involved the use of any respiratory protection during the application of asbestos

insulating materials. Although many lives were spared due to the unique fire resistant qualities of asbestos, 20 to 30 years after heavy exposures to this mineral proved to be catastrophic to the well-being of many a shipyard worker.

As the number of asbestos-related respiratory disorders increased during the 1960's through 1970's, Congress was forced to acknowledge the problem and initiate measures to control this new environmental hazard. This coupled with many personal lawsuits against asbestos manufacturers, served to fuel federal intervention as well as abatement activities

Advent of Asbestos Regulation

The early 1970's saw the birth of a regulatory framework to control both environmental and occupational asbestos exposures. The key players were the Environmental Protection Agency (EPA) and the Occupational Safety & Health Administration (OSHA) respectively. In May of 1971, OSHA published an airborne asbestos standard which included a Permissible Exposure Limit (PEL) of 12.0 fibers/cubic centimeter, which over the past years has been lowered in several steps, to the current PEL of 0.1 fibers/cc.

The Environmental Protection Agency initiated further control by banning spray-on asbestos containing materials for fireproofing in April of 1973, and later issuing a phase-out and overall ban on virtually all asbestos usage by the mid to late 1990's. However, this ban and phase-out rule was overturned and eliminated by court action. The rules and regulations governing asbestos exposure and abatement activities will be discussed in a later section of this manual.

TABLE 1-1 HISTORY OF ASBESTOS USES

- Archeological evidence indicates possible use during the Stone Age (in Pottery).
- The Greeks knew well its usefulness in items such as curtains, tablecloths and wicks in candles.
- There are records of cases of asbestos related diseases showing up in Egyptian slaves that wove asbestos into cloth.
- The Romans would wrap bodies in asbestos cloth before cremation, so they could collect the ashes easier.
- Some ancient civilizations believed that asbestos contained medicinal properties.
- The Chinese used asbestos in gunpowder.
- Charlemagne used a tablecloth, which was made of asbestos.
- Marco Polo recorded its use in the Great Empire of Tartary (part of Siberia).
- Use declined during the Middle Ages but it was still highly prized by Nobles and the Court of Kings.
- 1720; First mining & manufacturing of asbestos attempted in the Ural Mountains.
- Late 1800's; Commercial mining in Quebec and in Normandy (from 300 tons initially to well over 5 million tons in the 1970's).
- Asbestos was used in thermal insulation during the mid 1900's, as well as a fire retardant in the 1960's and 1970's.
- Even though use of friable asbestos materials has been banned in the United States, the use of non-friable asbestos products has soared until the 1980's.

**TABLE 1-2
ASBESTOS-CONTAINING MATERIALS FOUND IN BUILDINGS***

Subdivision	Generic Name	Asbestos (%)	Dates of Use	Binder/Sizing
Surfacing Material	Sprayed-on or Troweled-on	1 - 95	1935 - 1970	Sodium silicate Portland cement organic binders
Performed thermal insulating materials	Batts, blocks and pipe coverings	15	1926 - 1949	Magnesium carbonate
	Calcium silicate	6 - 8	1949 - 1971	Calcium silicate
Textiles	Cloth*			
	Blankets (fire)*	100	1910 – present	None
	Felts	90 - 95	1920 – present	Cotton / Wool
	Blue stripe	80	1920 – present	Cotton
	Red stripe	90	1920 – present	Cotton
	Green stripe	95	1920 – present	Cotton
	Sheets	50 - 90	1920 – present	Cotton / Wool
	Cord/rope/yarn*	80 - 100	1920 – present	Cotton / Wool
	Tubing	80 - 85	1920 – present	Cotton / Wool
	Tape/strip	90	1920 – present	Cotton / Wool
Cementitious concrete-like	Curtains* (theatre, welding)	60 - 65	1945 - present	Cotton
	Extrusion panels	8	1965 – 1977	Portland cement
Paper products	Corrugated	20 – 45	1930 – present	Portland cement
	Flat	40 – 50	1930 – present	Portland cement
	Flexible	30 – 50	1930 – present	Portland cement
	Perforated			
	Laminated (outer surface)	35 – 50	1930 – present	Portland cement
	Roof tiles	20 – 30	1930 – present	Portland cement
	Clapboard	12 – 15	1944 – 1945	Portland cement
	Siding shingles	12 – 14	Unknown - present	Portland cement
	Roofing shingles	20 – 32	Unknown - present	Portland cement
	Pipe	20 - 15	1935 - present	Portland cement
Roofing felts	Corrugated; High temp.	90	1935 – present	Sodium silicate
	Moderate temp.	35 – 70	1910 – present	Starch
	Indented	98	1935 - present	Cotton & organic binder
Roofing felts	Millboard	80-85	1925 – present	Starch, lime, clay
	Smooth surface	10 - 15	1910 – present	Asphalt
	Mineral surface	10 – 15	1910 – present	Asphalt
	Shingles	1	1971 – 1974	Asphalt
	Pipeline	10	1920 - present	Asphalt

Note: * The information is taken, with modification, from Lory, E.E. and Coin, D.C., *Management Procedure for Assessment of Friable Asbestos Insulating Material*, February, 1981, Port Hueneme, CA, Civil Engineering Laboratory Naval Construction Battalion Center. The U.S. Navy prohibits the use of asbestos-containing materials when acceptable non-asbestos substitutes have been identified.

Asbestos Containing Materials (ACM)

These are products, which contain greater than 1% when analyzed by Polarized Light Microscopy (PLM). These materials may be classed as friable or non-friable, and the products may be placed in one of the three categories of building materials as described below. The United States Environmental Protection agency (USEPA) and others distinguish between friable and non-friable forms of ACM. Friable ACM can be “crumbled or reduced to powder by hand pressure”. Other things being equal, friable ACM is thought to release fibers into the air more readily than non-friable materials, however, many types of non-friable ACM can also release fibers if disturbed.

Categories of Asbestos-Containing Building Materials (ACBM)

EPA identifies three categories of ACM used in buildings:

- ***Surfacing Materials*** - ACM sprayed or troweled on surfaces (walls, ceilings, structural members) for acoustical, decorative, or fireproofing purposes. This includes plaster and fireproofing insulation.
- ***Thermal System Insulation*** – Insulation used to inhibit heat transfer or prevent condensation on pipes, boilers, tanks, ducts, and various other components of hot and cold water systems and heating, ventilation, and air conditioning (HVAC) systems. This includes pipe lagging, pipe wrap; block, batt, and blanket insulation; cements and “muds”; and a variety of other products such as gaskets and ropes.
- ***Miscellaneous Materials*** – Other, largely non-friable products and materials such as floor tiles, ceiling tile, roofing felt, concrete pipe, outdoor siding and fabrics.

While it is often possible to “suspect” that a material or product contains asbestos by visual determination, actual determinations of asbestos content can only be made by laboratory analysis. The EPA requires that the asbestos content of suspect materials be determined by collecting bulk samples and analyzing them by PLM. The PLM technique determines both the percent and type of asbestos present in the bulk material.

CURRENT ISSUES

Asbestos is still used in the manufacture of several thousand products. The Federal government estimates that one-half of all multi-story buildings in the United States contain asbestos (probably a very conservative estimation). In one form or another, asbestos exists in millions of buildings across the country, including schools, homes, factories, hospitals and offices.

Of particular concern are those employees who must work on or come in contact with “friable” asbestos or materials which have deteriorated to the point where the asbestos

fibers are no longer, bound within its matrix. These are the fibers most likely to become airborne and pose the greatest threat to one's health.

As with all products subjected to the normal elements of use, the integrity of asbestos containing materials (ACM) is susceptible to gradual wear and disintegration. Therefore, their widespread applications in construction, industry, and transportation affords plenty of opportunity for continued episodic fiber releases to the environment and consequently, for worker exposures.

A prime contributor to the overall environmental burden of asbestos is the inadvertent demolition of buildings containing this contaminant in heavily populated areas. Because it is a mineral, asbestos does not biodegrade, but remains with us virtually forever.

Asbestos fibers are, for the most part, invisible. Inhaling these fibers does not produce any immediate effect and asbestos related diseases usually take years to develop. Such attributes tend to promote a false sense of security as well as easily relaxed attitudes about health and safety concerns. Table 1-3 summarizes some of the occupations at risk.

**TABLE 1-3
OCCUPATIONS AT RISK FOR ASBESTOS EXPOSURE**

Process	Products Made or Used	Jobs Potentially at Risk
Production Mining Milling Handling		Rock Mining, loading, trucking Crushing, milling Transport workers, dockers, loaders, those who unpack jute sacks (recently replaced with sacks that do not permit fibers to escape)
Primary uses in spray insulation	Spray of fiber mixed with oil	Spray insulators (construction, ship building)
Manufacture of Textiles	Cloth, curtains, lagging, protective clothing, mailbags, padding, conveyor belts	Blending, carding, spinning, twisting, winding, braiding, weaving, slurry mixing, laminating, molding, drying
Cement products	Sheets, pipes, roofing shingles gutters, ventilation shafts, flower pots	
"Paper" products	Millboard, roofing felt, fine quality electrical papers, flooring felt, fillers	
Friction materials	Automotive products, gaskets, clutch plates, brake linings	
Insulation products	Pipe and boiler insulation, bulkhead linings for ships	
Application New construction	Boards and tiles: putties, caulk, paints, joint fillers; cement products (tiles, pipes, siding, shingles)	Directly, carpenters, ladders, painters, tile layers, insulation workers, sheet metal and heating equipment workers, masons; indirectly all other workers on construction sites, such as plumbers, welders, electricians, demolition workers for all of these
Repair, demolition Shipbuilding Construction	Insulation materials (boards, mattresses, cloth) for engines, hull, decks, lagging of ventilation and water pipes	Ladders, refitters, strippers, steam fitters, sailmakers, joiners, shipwrights, engine fitters masons, painters, welders, caulkers

SECTION 2

IDENTIFICATION & CHARACTERIZATION OF ASBESTOS

INTRODUCTION

Asbestos is distinguished from other minerals by the fact that its crystals form long, thin fibers. Magnified 2000 times, asbestos fibers are shaped either like needles or wavy hairs and are as strong as steel wire. These microscopic fibers possess several desirable characteristics besides incredible tensile strength. These include: high density; high degree of flexibility; chemical resistance; bacterial resistance; good electrical insulator; non-combustible (at temps. <800); excellent thermal insulator; good friction and wear characteristics and desirable acoustical properties.

The fiber surface area is also highly absorbent making it an ideal component for the manufacturing of filter products, and as “active filler” constituent during the fabrication of products like cement, vinyl floor tiles, paints, and plastics. In the latter uses, asbestos fibers also serve as a reinforcing medium. This is accomplished by virtue of the chemical interaction of the surface of the fiber with the added components (the hydroxyl group-studded surface of the fiber).

Asbestos is a catch-all term describing a number of silicates, containing varying amounts of calcium, magnesium, and iron, occurring in metamorphic rock. Once liberated from the ore, it takes on the appearance of a fluffy mass that can be processed much like cotton or wool. However, in smaller concentrations, they are invisible to the human eye. Their incredible aerodynamic properties allow asbestos fibers to drift almost indefinitely on air currents. As a matter of fact, a fiber at eye level may take hours or even weeks to settle to the ground.

ASBESTOS TYPES

There are two major groups or classes of asbestiform minerals, known as the *serpentine*s and the *amphibole*s. The distinction between these two groups is based upon crystalline structure. Serpentine minerals have a sheet or layered structure, while amphibole minerals have a chain-like crystal structure.

There are six commonly recognized types of asbestiform minerals; chrysotile, amosite, crocidolite, actinolite, tremolite, and anthophyllite. Only the first three are widely produced commercially (see figure 2-1). U.S. markets used approximately 90% chrysotile (white asbestos), 9% amosite (brown asbestos), and 1% crocidolite (blue asbestos).

Chrysotile

Chrysotile has been the most widely used type of asbestos in the United States. White in its processed form, its high tensile strength and flexibility make it highly favored. It has been used extensively in the manufacture of insulating products (see Table 2-1).

Unaided by magnification, chrysotile is long and silky in appearance. Microscopic examination shows that chrysotile is a layered lattice of fine cylindrical/hollow tubes bundled together. Its chemical composition is mostly hydrated magnesium silicate, with several impurities, including iron, nickel, and chromium. Due to its layered structure, it is the only asbestiform mineral that belongs to serpentine group. It was commonly used in cement products, textiles, brake linings, and in several forms of thermal system insulation.

Amosite

Amosite, also known as brown asbestos, belongs to the amphibole group. Amosite usage accounts for a small percentage of the U.S. market, but can be found in many of the same products as chrysotile. Amosite was also used as a binder component in some plastics. It is ferrous magnesium silicate. An important feature of amosite from an abatement perspective is that it is more difficult to wet than other asbestos minerals.

Crocidolite

Less commonly used and carrying a greater health concern, crocidolite or blue asbestos is also an amphibole. Mined exclusively in South Africa, crocidolite is incredibly strong and characterized by thick, rigid fibers and is highly resistant to acids and weathering (see Table 2-1). Its chemical composition is sodium iron silicate. Though it is unclear why, this particular type of asbestos seems to lead the others in promoting cancer.

Anthophyllite, Actinolite and Tremolite

These three asbestos minerals are rare and of little commercial value, although they were used in a number of products and are sometimes found as contaminants along with the other more common types of asbestos minerals.

**Table 2-1
Varieties of Asbestos: Properties, Sources and Usage***

Mineral Type	Serpentine	Amphibole				
Chemistry, approximate	Mg ₃ Si ₂ O ₅ (OH) ₄	X ₂₋₃ Y ₅ (Si,A1) ₈ O ₂₂ (OH) ₂ with X,Y representing different elements				
Fiber Type	Chrysotile (white)	Crocidolite (blue)	Amosite (brown)	Anthophyllite	Tremolite	Actinolite
Main elements determining specific composition	Mg	Na, Fe ²⁺ , Fe ³⁺	Fe ²⁺ , Mg, Fe ²⁺	Similar to Amosite, but more Fe ²⁺ , less Mg	Ca, Mg	Like Tremolite, but contains , Fe ²⁺
Physical properties Tensile strength 1000 psi Flexibility Acid resistance Texture Heat resistance	350 – 450 Very good Poor Silky to harsh 500°C	500 Good Good Harsh 200°C	175 - 350 Poor Good Course 200°C	240 Fair to brittle Fair to good Harsh to soft 200°C	<75 Brittle Fair Harsh to soft Fair to good	Brittle Very good Harsh Very good
Main sources, present and future	Canada (Quebec, B.C. Yukon, Newfoundland, Ontario) Russia (Urais, Siberia) S. Rhodesia Botswana Swaziland Australia (NSW) Cyprus Italy United States (Vt, Ca, Az)	S, Africa (N. W. Cape, Transvaal) Bolivia W. Australia	S. Africa (Tvl)	Finland United States (Georgia+ Carolinas)	Italy	Not usually commercially exploited
World use, approx %	93	3.5	2.5	<1	<1	
Industrial uses	Textiles Cement products Friction materials Insulation** "Paper" products	Textiles Pressure pipes Cement products Felts for plastics	Cement Plastic re-inforcement Refractory tiles Pressure pipes	Cement (limited) Chemical industry	Chemical industry as fillers and filters; Talc fillers	

* Information collected by Dr. Graham Gibbs from the following reference sources: Zussman (3), Spell and Leineweber (18), N.W. Hendry, in (5), p. 12: R. Gaze, in (5), p. 23: K.V. Lindell, in (7), p. 323.
+ No longer in operation.
** Being phased out.

FIGURE 2-1 VARIETIES OF ASBESTOS: PROPERTIES, SOURCES, AND USAGE

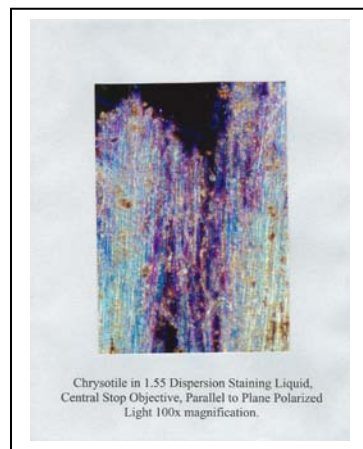
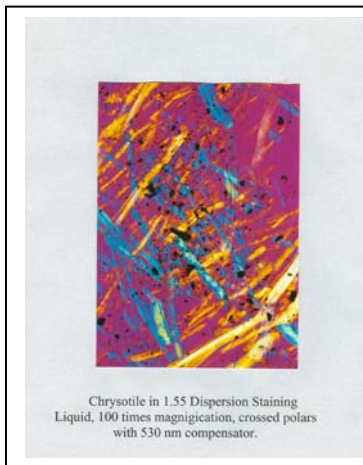
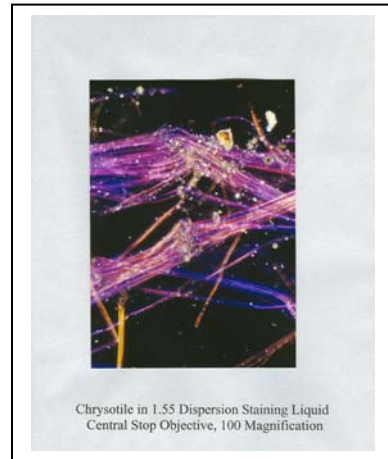
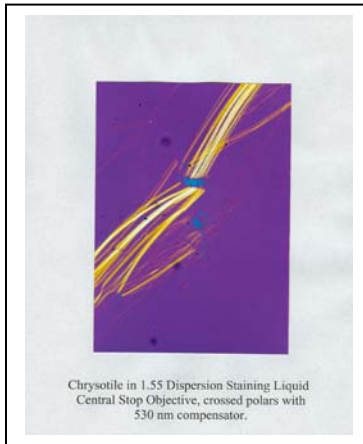
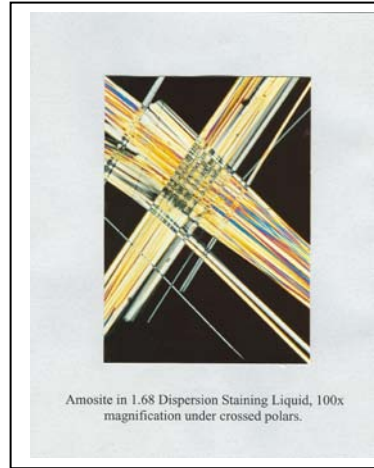
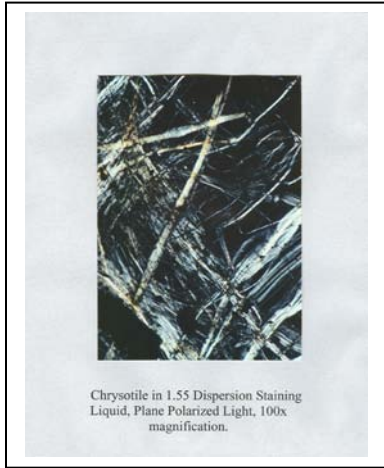

SECTION 3

HEALTH EFFECTS OF ASBESTOS AND MEDICAL SURVEILLANCE

INTRODUCTION

It may have been the Romans that first recognized a health risk with the use of asbestos. Available literature indicates that Roman slaves weaving asbestos cloth succumbed to disabling pulmonary diseases. This may have been the first account of asbestosis, now known to be a degenerative disease process linked to chronic asbestos exposure.

In the late 1800's, a Viennese physician wrote of how pulmonary problems and gastrointestinal disorders among asbestos workers and their families were quite common. During this same period, inspectors of various manufacturing plants in England often singled out those processes involving asbestos. They knew all too well that cases of respiratory impairment amongst workers in these areas were common and attributed them directly to asbestos exposures.

Great concern has been generated over potential low-level asbestos exposures of children in schools where asbestos materials exist. With the EPA's ruling on the ban of virtually all asbestos containing products by the late 1990's (now reversed by court action), there's no wonder why the public, on the whole, is close to hysteria over its presence around them.

However, to avoid hysteria or "**asbestosphobia**" it is important to understand the relationship between asbestos exposure and its potential to produce an effect on those functions of the human body most vulnerable to asbestos-related diseases. **How** asbestos enters the body, **where** it does its greatest damage and **why**, may serve as rational starting points to assess the extent of any asbestos exposure hazard.

ROUTES OF ENTRY

The routes by which asbestos fibers enter the body are through **Inhalation** (respiratory tract) and **Ingestion** (digestive tract). A third, but less emphasized pathway includes the **Skin**. Of the three, inhalation is by far the route of entry posing the greatest concern and is considered the *primary* route of entry. Because of its intimate relationship with the body's circulatory system and the constant need to provide cells with oxygen, the respiratory system provides a **direct** avenue of entry for a multitude of toxic airborne materials.

THE RESPIRATORY SYSTEM

The lung's primary function is the exchange of oxygen (O₂), which all cells need, and carbon dioxide (CO₂), a waste product produced by the body as a result of metabolic activity. As one inhales, air containing oxygen and other gases, as well as vast numbers of particulates, is drawn into the nose and/or mouth (see Figure 3-1).

The larger particles are filtered out in the nose by passing through thick nasal hairs and an intricate array of moist mucus covered pathways. The inhaled air mass continues on down through the pharynx, larynx and trachea (upper respiratory tract).

The airway branches into two primary passage ways (bronchi) and continue to branch out, dividing into smaller *secondary bronchi* and still smaller airways called *bronchioles*, finally terminating in the deep lung, at the alveolus or air sacs. These are considered the functional units of the lungs since they are the primary site of gaseous exchange between the blood and the inhaled air.

The exchange of gases (ie, respiration) occurs via a system of diffusion between capillary beds (very small blood vessels) and the very thin walls of the alveolar sacs (approx. 0.15 μm -5 μm thick). It has been estimated that the human lungs contain approximately 21 million alveolar sacs with 550 million individual alveoli. This totals a combined surface area of over 80 square meters!

THE THORACIC CAVITY/MECHANISM OF BREATHING

The thoracic region of the chest houses the right and left lungs. *Pleural membranes* separated by a thin layer of fluid, envelope the exterior of the lungs and the interior of the chest wall. This allows for the almost friction free surface required for lung expansion and contraction. When this fluid filled space is altered or damaged, severe difficulty in breathing occurs.

FIGURE 3-1
THE RESPIRATORY SYSTEM

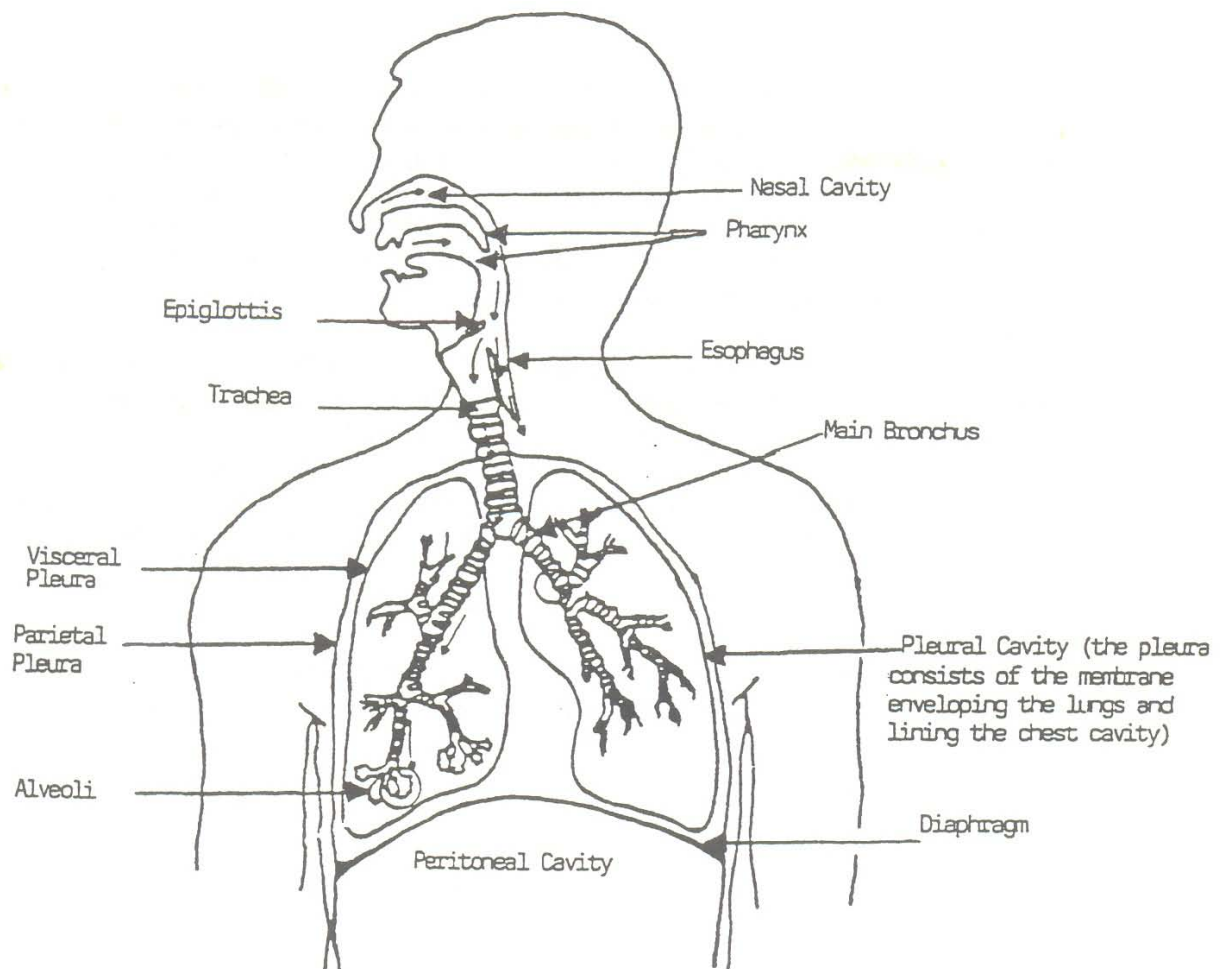

Routes of inhalation and ingestion of asbestiform fibers are shown by small arrows. Mesothelial cells line the outside of the lungs and the pleural and peritoneal cavities. Interaction of asbestos with these cells can result in either pleural or peritoneal mesothelioma. Adapted from Wagner, 1980. *

* Figure from Asbestiform Fibers, Non-Occupational Health Risks, National Research Council, National Academy Press, Washington, D.C, (1984) page 101.

PARTICLE DEPOSITION AND LUNG CLEARANCE MECHANISMS

Nose

The nose is the first line of defense against inhaled particulates. The thick hair at the entrance of both nostrils, as well as the high level of moisture, helps to filter out very large suspended particles. The nasal cavity continues to trap particles through the narrowing of nasal passages and through the folds of the mucus covered nasal turbinates. Here, particles impact the mucus lining of the passages as a result of the swirling and eddies of air currents caused by the turbulent flow of inhalation. Some of the particles may have sufficient inertia to impact on the back of the pharynx.

As a defense, the nose is almost 100% efficient in trapping particles 20 microns or larger. This trapping efficiency gradually decreases as the particle size decreases. Those particles trapped in the upper respiratory tract may also initiate a reflex, through irritation, commonly referred to as sneezing, which can force some deposited material out the nose. The cough mechanism is often stimulated when particle deposition occurs in the lining of the larynx, trachea or main stem bronchi. By creating a tremendous backpressure, particles are thrust upward toward the mouth for the purpose of expectoration or swallowing.

Those particles not trapped in the upper respiratory tract can gain access to the deeper areas of the lungs and are acted upon by additional defense mechanisms in these lower regions of the lung. As a general rule, the smaller the size of the particle, the deeper it can be deposited in the respiratory tract.

The defense mechanisms of the lungs include the *muco-ciliary* escalator comprised of a *mucus blanket* and *cilia*, as well as the particle engulfing cells called *macrophages*.

Muco-ciliary Escalator

Special cells (goblet cells) along the innermost layers of tissue in the trachea and bronchi produce continuous thin mucus covering (mucus blanket) which is constantly being directed up towards the mouth by tiny projections called cilia. These are small hair-like structures occurring on special cells in specific regions of the respiratory tract. Their presence ranges from areas in the nasopharynx to the regions extending between the trachea and the terminal bronchioles of the deep lung.

Through a kind of harmonic motion, the cilia move the mucus blanket (impregnated with trapped particles and debris) up towards the mouth where it may be coughed out or swallowed. It is a known fact that cigarette smoking temporarily paralyzes the action of cilia, inhibiting one of the body's most effective defenses against particulates. This is illustrated with the condition termed "smoker's hack" often appearing in the morning after a nights sleep. During sleep, the paralyzing effects of a days worth of cigarette smoking begins to wear off. The cilia begin beating normally, mobilizing large quantities of stagnant mucus towards the mouth. This produces the characteristic morning cough. The cough mechanism is again paralyzed with the first couple of cigarettes.

Macrophages

Those particles escaping the first few lines of defense may fall prey to mobile particle eating cells called *macrophages*. These special white blood cells cruise the deep lung region in pursuit of foreign materials, which have escaped other defenses. Although several types exist, their primary function is to engulf (phagocytize) material and digest it through the use of acids and enzymes. Asbestos fibers tend to pose special problems to the engulfing capabilities of macrophages and, as will be discussed elsewhere in this text, with often-detrimental results.

Lymphatic System

Another clearance/defense mechanism often overlooked includes the *lymphatic system*. Its importance becomes more apparent in dealing with those very small asbestos fibers penetrating into tissue spaces. See Figure 3-2 for a diagrammatic representation of clearance mechanisms for particles, including fibers.

FIGURE 3-2

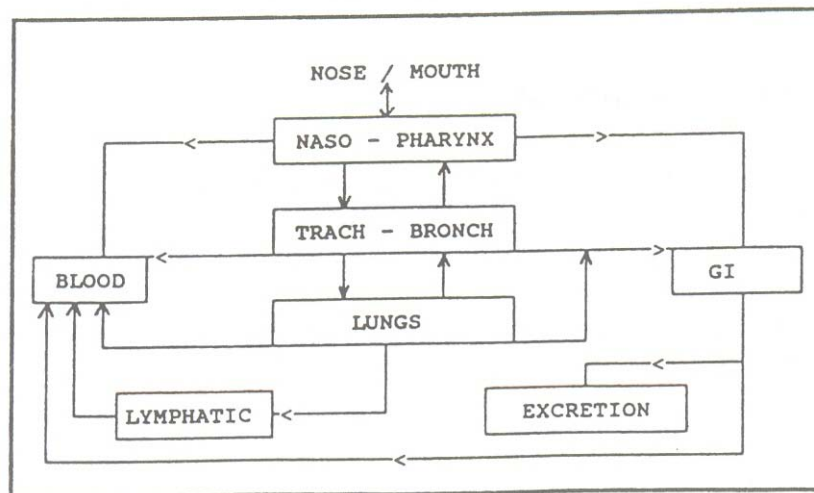

(->) Represents particle/fiber clearance routes

NATURE OF ASBESTOS RELATED DISEASES

The fate and biological effects of inhaled asbestos fibers depends on three primary factors:

1. Airway dimension.
2. The breathing patterns carrying the fibers.
3. The aerodynamic characteristics of the fibers.

The latter is mainly a function of diameter, but also involves size, shape, and density.

The size range of an asbestos fiber has been defined by various regulatory agencies as having a length greater than 5 microns, a maximum diameter less than 5 microns, and a length-to-diameter ratio equal to or greater than 3 (1centimeter=10,000 micrometers). Their lengths and diameters vary greatly, and this may play a critical role in causing various diseases. Both airway dimensions and breathing patterns help to govern fiber deposition in the lungs.

Once in the body, fibers may be cleared, retained in lung tissues, swallowed, or engulfed by defense cells called macrophages. When discussing asbestos related diseases, it can be said that the fate of the invading fiber determines the severity of the biological response. But these responses are far from uniform and vary greatly from one person to another. Just as some individuals resist colds and infections more successfully than others, so seems the circumstances surrounding asbestos related illness. What may constitute a disease causing exposure for one may cause no apparent harm to someone else.

DOSE-RESPONSE RELATIONSHIP

Perhaps the most fundamental concept used to describe the effects of a given amount (exposure) of an agent or contaminant and the resulting health effects is that of the dose response relationship. The concept is based on the following assumptions:

- The magnitude of a response is a function of the concentration of the chemical (or agent) at the biological site of action (target organ).
- The concentration at the site is a function of the dose and duration of exposure.

Dose is the concentration or amount of material to which the body is exposed. The biological *response* to a dose can be classified as either *toxic* or *non-toxic*. Typically, as the size of the dose increases, the potential for a toxic (harmful) response increases as well. It is not clear what the dose-response relationship is for the most minimal health effects attributed to asbestos exposure. However, the possibility exists that such abnormalities may develop in some individuals long after exposure to very low doses of asbestos.

Current evidence indicates that there exists an increased risk of developing some asbestos related disease with increases of asbestos exposure, for example, *asbestosis*. However, other studies have demonstrated that with brief low-level lung and gastro-intestinal exposures, asbestos-related diseases have appeared, such as *mesotheliomas* and *lung cancers*. This may be related to genetic susceptibility to the carcinogenic effects of asbestos. Thus, it would be appropriate to suggest that *no safe level* exists and that one should take reasonable protection against all asbestos fiber exposures.

Toxicity is the ability of a substance to produce an adverse or unwanted effect. Toxicity is an inherent property of a substance and cannot be changed.

DELAYED EFFECTS/LATENCY PERIOD

One of the more severe concerns over asbestos exposure involves the length of time between exposure and the occurrence of asbestos related diseases. As illustrated in Figure 3-3, this is termed a "latency period". A latency period is defined as the amount of time that elapses between an exposure and the first sign of damage. For asbestos exposures, this may involve a period of 15 to 40 years before a asbestos related disease makes itself known. It is important to note that the actual latency period may vary greatly depending upon the individual exposed and specific processes.

**Figure 3-3
Latency Period**

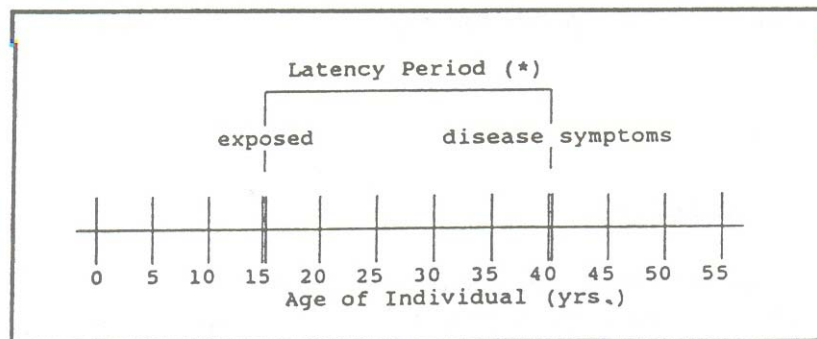

*Length of period varies with different asbestos diseases and different individuals.

COMMON ASBESTOS RELATED DISEASES

Pleural Plaques

Two types of pleural reactions have been associated with asbestos exposure:

1. A radiating response of inflammation accompanied by pleural space and lung tissue destruction.
2. A discrete reaction within the pleural membranes, in one or more locations.

The first may occur in association with all asbestos-related lung diseases, *pulmonary fibrosis*, or as a *pleural effusion*. The result of the second type of reaction is referred to as a pleural plaque.

Clinical Features & Diagnosis

Because they are often asymptomatic (present without symptoms), pleural plaques are usually diagnosed by observing chest x-rays in an otherwise healthy individual.

Pleural plaques have been found not only in exposed workers, but also in their family members as well. This implies that contaminated clothing or hair provide sufficient sources of secondary exposures.

Pleural plaques alone do not constitute a debilitating disease and are generally considered *benign*. They do not require any specific treatment. However, they can be considered a “signpost” or indicator of asbestos exposure and they do tend to increase the statistical likelihood of developing lung cancer. A dose-response relationship has not been confirmed. Plaque formation seems to be related to elapsed time from initial exposures rather than to the accumulated dose. A latency period ranging from 10 to 50 years after initial exposure has been documented.

Pleural Effusions

Clinical Features & Diagnosis

One of the most common health effects associated with asbestos exposure, as well as one of the few effects surfacing within ten years from initial exposure, the pleural effusion is a gradual (occasionally sudden) development of fluid in the pleural space between the chest wall and the surface of the lung. Although often asymptomatic, the presentation may be acute (sudden onset), accompanied with chest pain and fever. Often, the condition is associated with current or brief exposures occurring in the past. Pleural effusions may be benign and self-limiting or develop into a chronic condition of pleural thickening or pleural plaques.

Asbestosis

Asbestosis is classified as *pneumoconiosis*. It is **not** a cancer. Pneumoconiosis constitutes a group of lung diseases directly related to the chronic inhalation of high concentrations of dust (including fibers) in certain occupations. Fully described for the first time in the early twentieth century in asbestos textile workers, asbestosis was also the first asbestos-related disease to be recognized. Several disease-causing mechanisms have been equated to this chronically progressive, debilitating lung condition.

Fibrosis Formation: Unlike other digestible particles, asbestos does not respond to the digestive enzymes and acids of the macrophages. As a result, the macrophages eventually die and rupture, causing their contents to spill out into the surrounding areas, resulting in inflammation, which ultimately destroys normal lung tissue.

This process is continually repeated with the same fiber as well as others. So, not only is there a build-up of dead macrophages to contend with, but also the body's response to chronic irritation and tissue destruction. The loading of dead macrophages obstructs normal air sac function. The body attempts to heal itself through the formation of non-functional scar tissue. This chronic condition, producing scar tissue deposits of collagen, thickens air sac walls and develops into a progressive diffuse (spread throughout) fibrosis which greatly decreases lung function. It may also lead to a malignant cellular transformation.

Asbestos Bodies: The term "asbestos or ferruginous body" refers to the yellowish-brown particles, which are the hallmark of asbestos exposures. They consist of fibers that are heavily coated with a combination of proteins and iron-containing pigments. This encasement of fibers, as asbestos bodies, is a strong indicator of exposure and usually accompanies the diagnosis of asbestosis.

Clinical Features & Diagnosis

In simple terms, asbestosis is nothing less than gradual suffocation. Although not a cancer, lung function progressively deteriorates and the constant work of breathing causes an enlargement of the heart with subsequent circulatory impairment. This disease process may take 15 to 40 years before it results in clinical signs of disease, and smoking cigarettes may enhance its occurrence. Some of the clinical symptoms associated with asbestosis are synonymous with many other chronic obstructive pulmonary diseases and include the following:

- Progressive shortness of breath.
- Chronic cough, either dry or with sputum.
- Chest tightness accompanied with or without pain.
- Respiratory crepitations (rattles)
- Clubbing of the fingers and toes.
- Abnormal chest x-ray.
- Abnormal pulmonary function test.

The good news is that improved working conditions, personal protection protocols and employee awareness should virtually eliminate chronic exposure to high concentrations of asbestos dust thus making asbestosis a disease of the past, since development of asbestosis requires long exposures to high concentrations of asbestos fibers.

Lung Cancer

Asbestos is a known human carcinogen (cancer causing agent). Epidemiologic studies have unequivocally documented the association between asbestos exposure and the occurrence of various lung cancers, especially bronchogenic carcinomas (cancers of the bronchus or bronchi).

The underlying mechanism linking asbestos exposure to the initiation of malignant tumor growth is unclear, but fiber size appears to play a significant role.

Unlike asbestosis, chronic high exposures to asbestos fibers are not necessary to result in lung cancers. However, the extent of exposure (either high or low) may dictate the actual latency period for disease onset. In highly exposed workers, the latency period observed for asbestos induced lung cancer is 20 to 30 years.

Clinical Features & Diagnosis

The clinical features of lung cancer are common to many lung infections and may include the following symptoms:

- Persistent cough.
- An increase in sputum with cough.
- Blood-streaked sputum.
- Chest pain, unrelated to cough.
- Abnormal sputum cultures.
- Abnormal chest x-ray.
- Abnormal pulmonary function tests.

Crucial to regulatory agencies and the employee is the controversy surrounding whether there exists a safe or non-carcinogenic concentration of airborne asbestos. Currently, there is no conclusive evidence that such a threshold level, or safe dose, exists for the entire population.

SMOKING AND ASBESTOS EXPOSURE

There is little doubt that smoking cigarettes and exposure to asbestos is a potentially lethal combination. Epidemiologic studies have helped to clarify the risk factors, as well as demonstrate a potent synergistic or multiplicative effect on promoting lung cancer when both are present. However, it is unclear why the combined effects of smoking and asbestos exposure promote such a drastic increase in the risk of lung cancer. Table 3-1 presents the relative risks of asbestos exposure and smoking.

TABLE 3-1
RELATIONSHIP OF SMOKING & ASBESTOS EXPOSURE
TO RISK OF LUNG CANCER

Worker Status	Risk Multiplier
Nonsmoker/Asbestos Neg (-)	1
Nonsmoker/Asbestos Pos (+)	5
Smoker/Asbestos Neg (-)	10
Smoker/Asbestos Pos (+)	50-90

Note: (-) = No occupational exposure to asbestos
(+) = Occupational exposure to asbestos

Mesothelioma

Pleural membranes separated by fluid, envelope the exterior of the lungs (the pleura), abdominal cavity (peritoneum) and the heart (the pericardium). In all cases, these membranes act to reduce friction between organs and surrounding tissues. With the exception of the pericardium, primary malignant mesotheliomas (cancers) arising from the mesothelial cells of these membranes have been confirmed with low level, short duration exposures to asbestos fibers.

Although considered very rare cancers (incidence of the order of 1 per 1,000,000 per year in the general public), their association with asbestos exposure has been well documented since the early 1900's. The death of actor Steve McQueen attributed to a mesothelioma stimulated public interest and awareness of this rare disease.

Although all commercial fibers have been implicated, including talc, there seems to be important differences between fiber types in mesothelioma risk. The greatest risk appears to be associated with exposure to crocidolite (blue asbestos), less with amosite, and even less with chrysotile. These distinctions in response from different forms of asbestos are uniformly agreed upon within the scientific community. Smoking does not seem to play a synergistic role in the development of mesotheliomas, nor does there appear to be a dose-response relationship.

Clinical Features & Diagnosis

The underlying mechanism linking asbestos exposure to the development of mesotheliomas is unclear, but both fiber size and physical differences may play a significant role. There is some evidence that fibers less than 2.5 micrometers in diameter or between 10 and 80 micrometers in length are particularly effective in triggering mesothelioma growths.

As with lung cancer, the typical latency period is 20 to 40 years before the disease appears. The clinical features may include the following symptoms:

- Dull chest or shoulder pain, insidious at first but quite persistent to the point of interfering with sleep.
- Breathlessness, related to pleural fluid accumulation.
- Weight loss.
- Tiredness.
- Chronic cough.
- History of pleural effusions.
- Finger clubbing.
- Partial or complete intestinal obstruction.
- Abnormal chest x-ray.
- Abnormal pulmonary function tests.

The clinical course is usually quite rapid. For tumors involving the *pleura* (lung lining), the average survival time from onset of symptoms has historically been approximately 6 months. Recent advances in screening; diagnosis and treatment have increased survival time significantly. The typical survival time for those tumors of the *peritoneum* (gastrointestinal tract) is 13 to 14 months.

OTHER ASBESTOS-RELATED DISEASES

In addition to the above-mentioned diseases or conditions there is increasing evidence that other diseases may be attributable to asbestos exposures (see Table 3-2). An excess of gastrointestinal tract cancers and disorders, including cancers of the larynx, pharynx, stomach, colon and rectum have been documented in mortality studies of asbestos workers. Some evidence linking asbestos exposure to an increase in ovarian cancer among female asbestos workers has been documented in both clinical and animal studies, but has not been adequately substantiated. There has been some association of asbestos exposure with carcinoma of the breast in women, as well as genital carcinomas in men and women as well as kidney cancer.

Asbestos fibers can penetrate through the skin and give rise to “asbestos corns or warts.” In sufficient numbers, such corns appear to produce arthritis-like responses, including clubbing of fingers. There is also potential for asbestos corns to convert to malignancies. These conditions tend to be more prevalent in miners of raw ore and those employed in asbestos manufacturing plants.

HEALTH RISK ASSESSMENT

Asbestos Exposure Health Effects

Most of the evidence for a relationship between asbestos exposure and health effects is based on epidemiological studies. These studies, while presenting a relationship between exposure and disease, are from exposure data generated many years ago, during a period when workers were routinely exposed to much higher levels than they are today. It is not clear from these studies, if the dose-response relationship is linear, curved or if there is a threshold below which there is no effect. The vast majority of people who have developed asbestos related diseases were exposed to very high concentrations of fibers over an extended period of time, a condition very unlike that of building occupants or even abatement workers of today.

Many questions remain to be answered as to the development of disease and exposure to asbestos. Among these questions are:

- Do fiber size and shape make a difference? It is believed that long, thin fibers are more dangerous.
- Do different forms of asbestos present different levels of health risk? Sufficient evidence has not been presented as of yet.
- Do low levels of exposure present an increased risk? Asbestos fibers can be found in most human lungs at autopsy.
- Does asbestos exposure increase health risks from other types of chemical exposures? It has been shown through epidemiological studies that a relationship exists between smoking and increased risk of developing asbestos related illnesses.
- Are there specific genetic differences among individuals rendering some more susceptible to the carcinogenic effects of asbestos?

Related Health Effects

Exposure to other natural and man-made substances have been connected or suggested to produce similar health effects as those produced from exposure to asbestos, including:

- Erionite, a fibrous form of a mineral called *Zeolite*, which has been shown to produce mesothelioma in test animals.
- Ceramic fibers made from silicates which have been connected to pulmonary fibrosis and lung cancer.
- Fiberglass, which has been suggested to be linked to pulmonary fibrosis and lung cancer.

Health Risk to Family Members of Asbestos Workers

Exposures to asbestos fibers have not been confined to occupational settings. Asbestos related disease in persons who have not been directly exposed at the workplace has been reported since the early 1960's. Of considerable importance are the data on the prevalence of x-ray abnormalities and the incidence of mesothelioma in family contacts of asbestos workers. The source of exposure for this group of individuals is presumed to be the dust brought home on a worker's clothing.

TABLE 3-2
PATHOLOGICAL EFFECTS OF ASBESTOS EXPOSURE IN MAN

ORGAN	EFFECT	ASSOC WITH ASBESTOS EXPOSURE*
Skin	Asbestos Corn	Established
Larynx	Carcinoma	Possible
Lungs	Asbestos Bodies Interstitial Fibrosis (Asbestosis) Carcinoma (Bronchial)	Established Established Cofactor with Cigarettes
Pleura	Hyaline Plaques Malignant Mesothelioma Pleural Effusion	Established Established + Possible
Peritoneum	Malignant Mesothelioma	Established +
GI Tract	Neoplasia Carcinoma	Established Established
Ovary	Carcinoma	Remotely Possible
Breast	Carcinoma	Remotely Possible
Genitals (Male/Female)	Carcinoma	Remotely Possible

*Association thought to be causal, except where indicated.

+Association, not cause, established.

THE IMPORTANCE OF MEDICAL SURVEILLANCE

It is important for all companies or industries involved in any operations that may disturb asbestos to establish an ongoing medical surveillance program for several reasons. These include the safety and health of all employees, regulatory requirements and other legal liability concerns.

Through implementations of a sound medical surveillance program, a company will be able to verify every employee's medical status at time of employment, comply with OSHA standards on medical surveillance of workers exposed to asbestos, and reduce other associated liability risks.

WHO NEEDS MEDICAL SURVEILLANCE?

Some of the employees that should be provided medical surveillance include:

- Custodial and maintenance workers who may encounter asbestos-containing materials (ACM) while performing their normal duties.
- Asbestos abatement workers.
- Asbestos abatement air monitoring personnel.
- Building inspectors.
- Pipe fitters.
- Roofing workers.
- Laboratory personnel involved with asbestos analysis.
- Asbestos manufacturing personnel.
- Other allied trades that may encounter asbestos-containing materials.

According to Federal regulations, any employee working at an occupation in which the levels of airborne asbestos fibers meet or exceed certain levels must participate in a medical surveillance program. Additionally, any employee who must wear a respirator must be medically evaluated on a regular basis. This is to ensure that the use of the respirator does not adversely affect his or her health.

OSHA STANDARDS – MEDICAL SURVEILLANCE

According to the OSHA Asbestos Construction Standard 29 CFR 1926.1101, medical examinations must be provided or made available by the employer, at their expense, for all employees who are or will be exposed to airborne concentrations of asbestos at or above the Permissible Exposure Limit of 0.1 fibers per cubic centimeter (f/cc) during an 8 hour time weighted average (TWA) and/or the excursion limit of 1.0 f/cc during a 30 minute time weighted average for 30 or more days per year. This exposure is without regard to respirator use. An acceptable medical surveillance program must include pre-placement, annual, and termination examinations.

The initial pre-placement exam may be waived provided there is sufficient evidence that demonstrates that an employee has been examined in accordance with the standard, within the past year. This standard also outlines the requirements maintaining medical records on each employee.

Pre-Placement Exams

A pre-placement examination must take place prior to an employee's assignment to an occupation where they are exposed to airborne concentrations of asbestos. A comprehensive medical evaluation must be performed and should include as a minimum:

- A medical and work history
- A complete physical examination of all systems with emphasis on the respiratory system, the cardiovascular system and the digestive system.
- Completion of the respiratory disease standardized questionnaire (see Appendix D).
- A chest x-ray, at the discretion of the physician (posterior-anterior 14 x 7 inches).
- Pulmonary function test to include Forced Vital Capacity (FVC) (the maximum amount of air that can be expired from the lung after full inhalation) and Forced Expiratory Volume at 1 second (FEV¹) (the amount of air forcible expired in one second after full inhalation).
- Any additional tests deemed appropriate by the examining physician.

The results of this examination will be used to determine the employee's baseline health status, as well as to evaluate whether or not they should be allowed to wear respirators. The findings of the examination (Physician's Report) are reviewed with the employee and furnished to the employer for their files.

Only those items of the examination pertinent to potential asbestos exposure or respirator usage are reported to the employer. The employer must furnish a copy of the report to the employee upon request.

Individual test results are normally kept by the physician or clinic to maintain confidentiality. To assure the proper steps are taken, a copy of the medical monitoring and record keeping requirements of the OSHA Standard should be provided to the physician. It is very important for the employer to be sure the clinic maintains the results of all examinations as required by the Standard. In the event that an employee develops a health related problem, the employer will be able to check their records and confirm whether or not the condition could have occurred as a result of employment with their company.

In addition to the medical reports the employer should request that the physician provide a signed statement indicating the following:

- Whether or not an employee is capable of wearing a respirator.
- Any limitations associated with respirator use.
- Any other workplace limitations, (intense heat, extreme cold, etc.).

- Any detectable medical conditions that would place the employee at an increased risk of material health impairment from exposure to asbestos.
- The physician has reviewed the results of the exam with the employee.
- The physician has informed him/her of any medical conditions that may result from exposure to asbestos.

Information beyond this, such as medical history and contents of the medical questionnaire must be kept confidential and must not be transmitted to the employer or others without written consent by the employee. Naturally, results of other tests done as part of routine employment physicals, such as hearing or vision tests would be supplied to the employer.

Annual/Periodic Examinations

As an ongoing surveillance mechanism, periodic medical examinations must be made available annually. Such annual examinations must include, as a minimum, all elements of the initial exam with the exception of the chest x-ray requirement. OSHA provides guidelines for the frequency of chest x-rays depending upon the years since a first exposure and the age of the employee. In addition, an abbreviated questionnaire is substituted for the initial one and must be completed.

The physician will be able to compare the annual examinations with the pre-placement evaluations to determine if there are any changes in an employee's health status. If there are noticeable changes, such changes can be evaluated promptly to reduce any long-term health implications. Actions may include early medical treatment, transfer to another job, discontinue respirator use, etc.

Termination of Employment Examination

Within 30 calendar days before or after the termination of an employee, OSHA requires that each employee exposed to asbestos be offered a termination medical examination. The employee may waive his/her right to this exam, but this must be done in writing.

The termination examination must include those elements of a periodic exam. Records of these exams must be retained by the employer/building owner for a minimum period of 30 years to provide documentation of the health status of the employee. The reason for this 30-year period is due to the latency period associated with asbestos-related diseases (between 15-30 years). Thus, if an employee develops a health problem or files a disability claim 25 years later, the employer will have records on file for reference.

REASONS FOR SPECIFIC TESTS

Chest X-Ray: These are performed primarily to detect irregularities in the lungs and the heart, including any fibrosis or plural plaques induced by exposure to asbestos and are also used as a baseline for comparing against future x-rays.

Pulmonary Function: These tests are conducted to determine if a person's lungs are expanding normally, and if there is adequate air movement in and out of the lungs. The FVC and FEV 1.0 are conducted through the use of a spirometer. The spirometer measures the ventilatory capacity of the lungs. Changes in the ability of an individual to move air into and out of the lungs, in a normal manner, can be described as either restrictive or obstructive ventilatory impairment.

Pulmonary History: This part of the examination is simply a questionnaire that is completed by the employee. It is used to identify the potential for respiratory diseases. Several questions relate to chronic lung diseases, while others address the employee's personal habits such as smoking.

Physical Examination: The routine physical examination often includes medical history, blood pressure, pulse, vision (depth perception, peripheral), audiogram (hearing test), urinalysis, and follow-up classification with appropriate recommendations. It is good recommended practice to require individuals over 40 years of age, or other people who might be at an increased risk, to have an electrocardiogram performed. It is a known fact that the use of respirators places increased strain on the cardio-pulmonary system. If abnormalities show up on an electrocardiogram, appropriate actions can then be taken; such as administration of medication or transfer to a job that does not require respirator use.

ACCESS TO MEDICAL AND EXPOSURE RECORDS

U.S. Department of Labor
Ann McLaughlin, Secretary
1988 OSHA 3110

OSHA
John Pendergrass, Asst. Secretary

INTRODUCTION

More than 32 million workers may be exposed to toxic substances and harmful physical agents to an extent that may severely impair their health. Yet workers are often the least informed about the toxic exposures they face and their potential health effects.

*In 1980, the Occupation Safety and health Administration (OSHA) issued a standard requiring employers to provide employees with information to assist in the management of their own safety and health. The standard, "Access to Employee Exposure and Medical Records" (29 CFR 1910.1020), permits direct access by employees or their designated representatives and by OSHA to employer-maintained exposure and medical records. * This access is designed to yield both direct and indirect improvements in the detection, treatment, and prevention of occupational disease. For example, access to these records will enable workers to determine patterns of health impairment and disease and to establish causal relationships between disease and exposure to particular hazards. Access to these records also should result in a decreased incidence of occupational exposure and should aid in designing and implementing new control measures*

*Although OSHA revised the standard in 1988 to eliminate certain recordkeeping requirements and to provide additional protection for employer trade secrets, the standard still provides employees with basic right to know the extent of their exposure to the harmful substances they work with and any associated health effects. This knowledge, in turn, allows them to detect, treat, and help prevent occupational disease. ***Note:** The standard limits access only to those employees who are, have been (including former employees), or will be exposed to toxic substances or harmful physical agents.*

ACCESS

"Access", for the purpose of the standard, means the right and opportunity to examine and copy. Access to employee medical and exposure records must be provided in a reasonable manner and place. If access cannot be provided within 15 days after the employee's request, the employer must state the reason for the delay and the earliest date when the records will be made available. Responses to initial requests, and new information that has been added to an initial request, are to be provided without cost to the employee or representative. The employer may give employees copies of the requested records, give the employees the records and the use of mechanical copying facilities so the employee may copy the records, or lend employees their records for copying off the premises. In addition, medical and exposure records are to be made available, on request, to OSHA representatives to examine and copy.

Exposure Records

Upon request, the employer must provide the employee, or employee's designated representative access to employee exposure records. If no records exist, the employer must provide records of other employees with job duties similar to those of the employee. Access to these records does not require the written consent of the other employees. In addition, these records must reasonably indicate the identity, amount, and nature of the toxic substances or harmful physical agents to which the employee has been exposed. Union representatives must indicate an occupational health need for requested records when seeking access to exposure records without the written authorization of the employee(s) involved.

Medical Records

The employer also must provide employees and their designated representatives access to medical records relevant to the employee. Access to the medical records of another employee may be provided only with the specific written consent of that employee. The standard provides a suitable sample authorization letter for this purpose (see page 7 for sample authorization). Prior to employee access to medical records, physicians, on behalf of employers, are encouraged to discuss with employees the contents of their medical records. Physicians also may recommend ways of disclosing medical records other than by direct employee access. Where appropriate, a physician representing the employer can elect to disclose information on specific diagnoses of terminal illness or psychiatric conditions only to an employee's designated representative, and not directly to the employee. In addition, a physician, nurse, or other responsible health care person who maintains medical records may delete from requested medical records the names of persons who provided confidential information concerning an employee's health status.

Analyses Using Exposure or Medical Records

The standard assures that an employee (or designated representative), as well as OSHA, can have access to analyses that were developed using information from exposure or medical records about the employee's working conditions or workplaces. Personal identities, such as names, addresses, social security and payroll numbers, age, race, and sex, must be removed from the data analyses prior to access.

Trade Secrets

In providing access to records, an employer may withhold trade secret information but must provide information needed to protect employee health. Where it is necessary to protect employee health, the employer may be required to release trade secret information but may condition access on a written agreement not to abuse the trade secret or to disclose the chemical's identity.

An employer also may delete from records any trade secret that discloses manufacturing processes or the percentage of a chemical substance in a mixture. The employer must, however, state when such deletions are made. When deletion impairs the evaluation of where or when exposure occurs, the employer must provide

alternative information that is sufficient to permit the requester to make such evaluations.

The employer also may withhold a specific chemical identity when the employer can demonstrate it is a trade secret, the employer states this to the requester, and all other information on the properties and effects of the toxic substance is disclosed. The specific chemical identity, however, must be disclosed to a treating physician or nurse that physician or nurse states that a medical emergency exists and the identity is necessary for treatment. When the emergency is over, the employer may require the physician or nurse to sign a confidentiality agreement.

The employer must provide access to a specific chemical identity in non-emergency situations to an employee, an employee's designated representative or a health care professional if it will be used for one or more of the following activities:

- *Assess the hazards of the chemicals to which employees will be exposed.*
- *Conduct or assess sampling of the workplace atmosphere to determine employee exposure levels.*
- *Conduct pre-assignment or periodic medical surveillance of exposed employees.*
- *Provide medical treatment to exposed employees.*
- *Select or assess appropriate personal protective equipment for exposed employees.*
- *Design or assess engineering controls or other protective measures for exposed employees.*
- *Conduct studies to determine the health effects of exposure.*

In these instances, however, the employer may require the requester to submit a written statement of need, the reasons why alternative information will not suffice, and to sign a confidentiality agreement not to use the information for any purpose other than the health need stated and not to release it under any circumstances, except to OSHA.

The standard further prescribes the steps employers must follow if they decide not to disclose the specific chemical identity requested by the health professional, employee, or designated representative. Briefly, these steps are as follows:

- *Provide a written denial.*
- *Provide the denial within 30 days of the request.*
- *Provide evidence that the chemical identity is a trade secret.*
- *Explain why alternative information is adequate.*
- *Give specific reasons for the denial.*

An employee, designated representative, or health professional may refer such a denial to OSHA for review and comment.

EMPLOYEE INFORMATION

At the time of initial employment and at least annually thereafter, employees must be told of the existence, location, and availability of their medical and exposure records. The employer also must inform each employee of his or her rights under the access standard and make copies of the standard available. Employees also must be told who is responsible for maintaining and providing access to records.

TRANSFER OF RECORDS

When an employer ceases to do business, he or she is required to provide the successor employer with all employee medical and exposure records. When there is no successor to receive the records for the prescribed period, the employer must inform the current affected employees of their access rights at least 3 months prior to the cessation of business and must notify the Director of the National Institute for Occupational Safety and Health (NIOSH) in writing at least 3 months prior to the disposal of records.

RETENTION OF RECORDS

Each employer must preserve and maintain accurate medical and exposure records for each employee. The access standard imposes no obligation to create records but does apply to any medical or exposure records created by the employer in compliance with other OSHA rules or at his or her own violation.

Exposure records and data analyses based on them are to be kept for 30 years. Medical records are to be kept for at least the duration of employment plus 30 years. Background data for exposure records such as laboratory reports and work sheets need to be kept only for 1 year. Records of employees who have worked for less than 1 year need not be retained after employment, but the employer must provide these records to the employee upon termination of employment. First-aid records of one time treatment need not be retained for any specified period.

OSHA does not mandate the form, manner, or process by which an employer preserves a record, except that chest X-ray films must be preserved in their original state. Three months before disposing of records, employers must notify the Director of NIOSH.

HAZARD COMMUNICATION

The OSHA Hazard Communication Standard (29 CFA 1910.1200) helps reduce the incidence of illnesses and injuries caused by chemical hazards in the workplace by informing employees of the nature and effect of hazardous materials they work with. The standard requires the development of Material Safety Data Sheets (MSDS's) and their communication to all employees exposed to chemical hazards. An MSDS describes the physical and chemical properties of products, health hazards and routes of exposure, precautions for safe handling and use, emergency and first-aid procedures, reactivity data, and control measures. Information on an MSDS aids in the selection of safe products and their safe handling and use, and helps employees to respond effectively to emergency situations.

OSHA's Access rule supplements the Hazard Communication Standard and its informational benefits for employees by adding information on exposure and medical effects. Both standards together give employees and employers the information they need to help avoid, reduce or eliminate workplace hazards.

STATE PLAN STANDARDS

States with OSHA approved occupational safety and health programs must adopt an access standard that is at least as effective as OSHA's standard, subject to OSHA approval and monitoring (see page 8 for state plan states). Since the requirement is that state standards be "at least as effective as" the federal rule, they may differ in some respects.

**Sample Authorization Letter for the Release of Employee Medical Record
Information to a Designated Representative
(Non-mandatory)**

I _____, hereby authorize
(Full name of worker/patient)

_____, to release to
(Individual or organization holding the medical records)

_____, the following medical
(Individual or organization authorized to receive the medical information)

information from my personal medical records: _____
(Describe generally the information desired to be released)

I give my permission for this medical information to be used for the following purpose:

but I do not give permission for any other use or re-disclosure of this information.

**Note: several extra lines are provided below so that you can place additional restrictions on this authorization letter if you want to. You may, however, leave these lines blank. On the other hand, you may want to: (1) Specify a particular expiration date for this letter (if less than 1 year); (2) Describe medical information to be created in the future that you intend to be covered by this authorization letter; or (3) Describe portions of the medical information in your records that you do not intend to be released as a result of this letter.*

Full name of Employee or Legal Representative

Signature of Employee or Legal Representative

Date of Signature

STATES WITH APPROVED PLANS

*Jim Sampson, Commissioner
Alaska Dept. of Labor
PO Box 21149
Juneau, Alaska 99802-1149
907-465-2700*

*Allen J. Meier, Commissioner
Iowa Division of Labor Services
1000 E. Grand Avenue
Des Moines, Iowa 50319
515-281-3447*

*Larry Etchechury, Director
Industrial Commission of Arizona
800 W. Washington
Phoenix, Arizona 85007
602-255-5795*

*Carole Palmore, Secretary
Kentucky Labor Cabinet
U.S. Highway 127 South
Frankfort, Kentucky 40601
502-564-3070*

*Ron Rinaldi, Director
California Dept. of Industrial
Relations
525 Golden Gate Avenue
San Francisco, California 94102
415-557-3356*

*Henry Koellein, Jr., Commissioner
Maryland Division of Labor & Industry
Dept. of Licensing & Regulations
501 St. Paul Place
Baltimore, Maryland 21202-2272
301-333-4176*

*Betty L. Tianti, Commissioner
Connecticut Dept. of Labor
200 Folly Brook Blvd.
Wethersfield, Connecticut 06109
203-566-5123*

*Mario R. Ramil, Director
Hawaii Dept. of Labor & Industrial
Relations
830 Punchbowl Street
Honolulu, Hawaii 96813
808-548-3150*

*Elizabeth Howe, Director
Michigan Dept. of Labor
309 N. Washington
PO Box 30015
Lansing, Michigan 48909
517-373-9600*

*Donald W. Moreau, Commissioner
Indiana Dept. of Labor
1013 State Office Bldg.
100 North Senate Avenue
Indianapolis, Indiana 46204
317-232-2663*

*Raj M. Wiener, Acting Director
Michigan Dept. of Public Health
3423 North Logan Street
Box 30195
Lansing, Michigan 48909
517-335-8022*

*Ray H. Bohn, Commissioner
Minnesota Dept. of Labor & Industry
443 Lafayette Road
St. Paul, Minnesota 55101
612-296-2342*

*Juan Manuel Rivera Gonzalez, Secretary
Puerto Rico Dept. of Labor & HR
Prudencio Rivera Martinez Bldg.
505 Munoz Rivera Avenue
Hato Rey, Puerto Rico 00918
809-754-2119-22*

*Michael J. Tyler, Administrator
Nevada Dept. of Industrial
Relations
Division of Occupational Safety &
Health
Capitol Complex
1370 S. Curry Street
Carson City, Nevada 89710
702-885-5240*

*Edgar L. McGowan, Commissioner
South Carolina Dept. of Labor
3600 Forest Drive
PO Box 11329
Columbia, South Carolina 29211
803-734-9594*

*Richard Mitzelfelt, Director
New Mexico Environmental
Improvement Division
Health & Environment Dept.
PO Box 968
Santa Fe, New Mexico 87504
505-827-2850*

*James R. White, Commissioner
Tennessee Dept. of Labor
Attn: Robert Taylor
501 Union Bldg.
Ste. A 2nd Floor
Nashville, Tennessee 37219
615-741-2582*

*Thomas F. Hartnett,
Commissioner
New York Dept. of Labor
One Main Street
Brooklyn, New York 11201
718-797-7281*

*Douglas J. McVey, Administrator
Utah Occupational Safety & Health
160 East 300 South
PO Box 5800
Salt Lake City, Utah 84110
801-530-6900*

*John C. Brooks, Commissioner
North Carolina Dept. of Labor
4 West Edenton Street
Raleigh, North Carolina 27603
919-733-7166*

*Jeanne Van Vlandren, Commissioner
Vermont Dept. of Labor & Industry
120 State Street
Montpelier, Vermont 05602
802-828-2765*

*John A. Pompei, Administrator
Accident Prevention Division
Oregon Dept. of Insurance &
Finance
Labor & Industries Bldg.
Salem, Oregon 97310
503-378-3304*

*Paul Arnold, Commissioner
Virgin Island Dept. of Labor
Box 890 Christiansted
St. Croix, Virgin Islands 00820
809-773-1994*

*Carol Amato, Commissioner
Virginia Dept. of Labor & Industry
PO Box 12064
Richmond, Virginia 23241
804-786-2376*

Joseph A. Dear, Director
Washington Dept. of Labor & Industries
General Administration Bldg.
Room 334-AX-31
Olympia, WA 98504
206-753-6307

John Chambers, Assistant
Administrator
Wyoming Dept. of Occupational
Health & Safety
604 East 25th Street
Cheyenne, WY 82002
307-777-7786 or 777-7787

**Approved state plans are required to provide standards and enforcement programs, as well as voluntary compliance activities that must be at least as effective as the federal OSHA standard.*

Note: Connecticut and New York plans cover public employees only.

In California, OSHA currently is exercising concurrent private-sector federal enforcement authority.

RELATED PUBLICATIONS

Single free copies of the following publications can be obtained from the OSHA Publications Office, U.S. Department of Labor, 200 Constitution Avenue, N.W., Room N-3101, Washington, D.C., 20210. Send a self-addressed mailing label with your request.

OSHA 2056 - ALL ABOUT OSHA
OSHA 3084 - CHEMICAL HAZARD COMMUNICATION
OSHA 3047 - CONSULTATION SERVICES FOR THE EMPLOYER
OSHA 3021 - OSHA: EMPLOYEE WORKPLACE RIGHTS
OSHA 2098 - OSHA INSPECTIONS
OSHA 3077 - PERSONAL PROTECTIVE EQUIPMENT
OSHA 3079 - RESPIRATORY PROTECTION
OSHA 3091 - SAFETY AND HEALTH GUIDE FOR THE CHEMICAL INDUSTRY
OSHA 2254 – TRAINING REQUIREMENTS IN OSHA STANDARDS AND TRAINING GUIDELINES
BLS Publication OMB No. 1220-0029 - Recordkeeping Guidelines for Occupational Injuries and Illnesses.

A "Hazard Communication Compliance Kit" may be ordered from the Superintendent of Documents, Government Printing Office, Washington, D.C. 20402 for \$18.00 (\$22.50 for foreign addresses). Specify OSHA Publication 3104, GPO Order Number 929-022-00000-9. The kit can be ordered from GPO by phone using VISA or MasterCard; call 202-783-3238.

SECTION 4

ASBESTOS LAWS, REGULATIONS AND GUIDELINES

INTRODUCTION

Several Federal laws, regulations and guidelines regarding asbestos and asbestos-containing materials have been established in the United States to reduce the risk to workers, the community and the environment. The most recent OSHA standards for asbestos in General Industry, Construction and Maritime became effective on October 11, 1994. These laws and regulations establish acceptable work practices, mandate specific training requirements, outline medical surveillance and exposure criteria as well as set forth several administrative responsibilities. Other Federal regulations cover the use of asbestos in products (EPA), transportation (DOT) and disposal (EPA) of asbestos waste as well as asbestos installed in school buildings (EPA).

In addition to Federal regulations, several states and local entities have established asbestos regulations which govern abatement activities, air monitoring/testing criteria and transportation/disposal requirements. Many of these rules, because they are more stringent, supersede Federal laws, especially with regard to ACM disposal and worker accreditation or certification. Therefore, it is important to become highly familiar with all regulations prior to undertaking any activities involving asbestos.

This section outlines the key aspects of current primary Federal, State and local regulations and industry standards that govern activities involving asbestos and asbestos-containing building materials (ACBM). In addition, this section addresses a number of notices and permits which either must be applied for and received, or which must be forwarded to governmental agencies before the start of work involving asbestos. Its intention is to provide a brief overview of the regulatory framework as well as to summarize current, key elements of specific regulations designed to protect the worker, community and the environment. The complete text of many of the primary Federal and State regulations have been provided under separate cover and must be referred to for specific applications.

REGULATORY FRAMEWORK

Federal Level

The Environmental Protection Agency (EPA) and the Occupational Safety and Health Administration (OSHA) under the Department of Labor (DOL) are the principal Federal agencies responsible for establishing and implementing regulations regarding asbestos in buildings and worker protection. The EPA is responsible for developing and enforcing regulations necessary to protect the general public from exposure to airborne contaminants that are known to be hazardous to human health. OSHA is responsible for the health and safety of workers who may be exposed to asbestos in the workplace, or in connection with their jobs. Several other agencies contribute to the regulatory

process, including the National Institute for Occupational Safety and Health (NIOSH) and the Department of Transportation (DOT).

State Level

The New York State Department of Labor (NYSDOL), the New York State Department of Health (NYSDOH) and the New York State Department of Environmental Conservation (NYSDEC) are the primary State agencies responsible for establishing and implementing regulations regarding asbestos abatement, worker training programs, worker protection and disposal of asbestos waste materials in New York State.

Local Level

In New York City, the New York City Department of Environmental Protection and the New York City Department of Sanitation regulate abatement, transportation, storage and disposal of asbestos within the City.

REGULATIONS

At the Federal level, there are five key regulations designed in whole or in part to control asbestos. They are:

1. EPA Asbestos Hazard Emergency Response Act (AHERA), 40 CFR Part 763, Subpart E.
2. EPA National Emission Standards for Hazardous Air Pollutants (NESHAPs) 40 CFR Part 61, Subparts A&M.
3. EPA Worker Protection Rule, 40 CFR Part 763, Subpart G.
4. OSHA Asbestos Standard for General Industry, Construction and Maritime, 29 CFR 1910.1001, 1926.1101 & 1915.1001.
5. DOT Hazardous Substances 49 CFR Part 171 & 172.

At the New York State Level there are eight key areas of regulatory authority over asbestos. They are:

1. NYSDEC Waste Collector Registration Regulations Title 6, Part 364 of the New York State Official Compilation of Codes, Rules and Regulations (6 NYCRR 364).
2. NYSDEC Solid Waste Management Regulations Title 6, Part 360 of the New York State Official Compilation of Codes, Rules and Regulations (6 NYCRR 360)

3. NYSDOL Asbestos Industrial Code Rule 56, Title 12, Part 56, of the New York State Official Compilation of Codes, Rules and Regulations (12 NYCRR 56)
4. NYSDOL Public Employees Safety and Health Act Article 2, Section 27 (a) of the New York State Labor Law as amended effective August 2, 1985.
5. NYSDOL Asbestos or Products Containing Asbestos Licensing Article 30, Sections 900-911 of the New York State Labor Law Created by Laws of 1986, Chapter 775.
6. NYSDOH Laboratory Accreditation Requirements Title 10, Parts 55.2 and 55.3 of the New York State Official Compilation of Codes, Rules and Regulations (10 NYCRR 55.2 & 55.3).
7. NYSDOH Laboratory Accreditation Requirements Article 502 of the New York State Health Laws.
8. NYSDOH Asbestos Safety Program Requirements Title 10, Part 73 of the New York State Official Compilation of Codes, Rules and Regulations (10 NYCRR 73).

FEDERAL REGULATIONS

AHERA

Congressional action concerning asbestos in schools began with the Asbestos School Detections and Control Act of 1980. The purpose of this law was to offer technical assistance to schools concerned about the potential health effects of friable asbestos. The program was administered by the U.S. Education Department, but was ineffective due to lack of sufficient funding. In 1982, the EPA expanded the technical assistance program and issued inspection regulations under the Asbestos-In-Schools Rule. The rule required all public and private schools to inspect their buildings for friable asbestos materials. Schools were required to complete their inspections by June 28, 1983. The rule also required schools to take samples and have them analyzed for asbestos, maintain records, and notify employees and parents of any identified asbestos. Actual abatement was not required by the rule. By 1985, Congress determined the need for new statutory authority to force schools to abate asbestos hazards. On October 22, 1986, President Reagan signed into law (as Title II of the Toxic Substance Control Act) the Asbestos Hazard Emergency Response Act (AHERA, Asbestos Containing Materials in School, 40 CFR Part 763, Subpart E). AHERA was more inclusive than the Asbestos-In-School Rule. The law directed EPA to publish regulations for addressing asbestos in public and private schools, grades K-12. The proposed rules were promulgated in the Federal Register on April 30, 1987. The Final rules were issued on October 30, 1987. AHERA established a number of requirements, with deadlines, for the EPA, which is summarized below.

Key Definitions

Asbestos Containing Materials (ACM) is defined as any material or product that contains more than 1% asbestos.

Asbestos Containing Building Materials (ACBM) are defined as surfacing ACM, thermal system insulation ACM, or miscellaneous ACM found on the interior structural members or other parts of school buildings.

Surfacing Materials are defined as material that is sprayed on, troweled on, or otherwise applied to surfaces, such as acoustical plaster on ceilings and fireproofing materials on structural members.

Surfacing ACM is surfacing material that contains more than 1% asbestos.

Thermal System Insulation is material applied to pipes, fittings, boilers, breeching, tanks, ducts or other structural components to prevent heat loss or gain or water condensation.

Miscellaneous Materials are interior building materials that contain more than 1% asbestos.

Friable means a dry material that may be crumbled pulverized or reduced to powder by hand pressure.

Homogeneous Area is an area of surfacing material, thermal system insulation or miscellaneous material that is uniform in color and texture.

EPA REQUIREMENTS UNDER AHERA

<u>DATE</u>	<u>REQUIRED ACTION</u>
4/20/87	Publish proposed rules. Develop a Model Accreditation Plan.
10/17/87	Publish final rules. National Bureau of Standards (NBS) to establish laboratory accreditation for bulk sample analysis. States must notify schools where to send management plans, and must establish review of filed plans.
10/12/88	NBS must establish lab accreditation program for air sample analysis. Schools must submit management plans to states.
07/89	Schools must implement management plans.

Responsibilities of Schools (LEAs) under AHERA:

- Inspections, surveillance, management plans and response actions must conform to EPA regulations.
- Maintenance employees must be properly trained in Operations and Maintenance (O&M).
- Warning labels must be posted.
- Management plans must be available for inspection by parents, employer organizations, etc.
- LEAs must designate a responsible person.

Inspections and Re-inspections:

- LEAs must inspect each school building leased, owned or otherwise used as a school building for friable and non-friable ACBM.
- Accredited Inspectors must visually inspect each area of a school building.
- All suspect materials are to be sampled or be assumed to contain asbestos.
- All suspect ACBM must be touched to confirm friability.
- Re-inspection must occur at least once every 3 years by an accredited Inspector.
- An accredited Management Planner must review each inspection, re-inspection and assessment.

Response Actions:

- LEAs must select and implement response actions consistent with the results of the building inspection and assessment.

Worker and Occupant Protection:

- AHERA extended coverage of the EPA Worker Protection Rule to maintenance and custodial personnel.
- Requires air monitoring to document exposures.
- LEAs may choose to institute the provision of Appendix B of the Act in the case of small-scale, short duration projects.

- Establishes basic occupant protection requirements, including restricted access, posting of signs, etc.

Management Plans:

- Must be developed by accredited Management Planners and submitted to the state governor on or before 10/12/88. Must implement plan by 7/9/89.
- Must contain descriptions/locations of all assumed and confirmed ACBM, inspection results, response actions, LEA designate, description of occupant notification procedures, and an evaluation of resources needed to complete response actions.

RESPONSE ACTIONS

CLASSIFICATION

ACTION

Damaged or Significantly Damaged Thermal Insulation

Repair damaged area or remove if Damaged repair not feasible. Maintain all thermal insulation and covering in an intact, undamaged state.

Damaged Friable Surfacing ACBM or Damaged Friable Miscellaneous ACBM

Select encapsulation, enclosure, removal or repair depending on building ACBM usage patterns and economic factors.

Significantly Damaged, Friable Surfacing ACBM or Significantly Damaged, Friable Miscellaneous ACBM

Isolate space and restrict access. Remove the material or enclose or encapsulate if sufficient to contain fibers.

Friable Surfacing, Thermal System or Miscellaneous ACBM with Potential for Damage.

Establish an O&M program.

Friable Surfacing, Thermal System or Miscellaneous ACBM with Potential for Significant Damage

Establish an O&M program. Institute measures to prevent damage. Remove material when preventative measures cannot be implemented.

Enforcement:

- Establishes civil penalties for violations.
- Each building in a state of non-compliance constitutes a separate violation.
- Criminal penalties may be assessed for willful violations.

Model Accreditation Plan:

The original Model Accreditation Plan (MAP), developed by the EPA pursuant to a provision of the Asbestos Hazard Emergency Response Act (Section 206 of TSCA), required accreditation for all persons who inspect school buildings for the presence of asbestos, develop school asbestos management plans, or design/conduct response actions with respect to friable asbestos in schools. After consulting with affected organizations, as required by AHERA, the EPA issued the current MAP which specifies minimum training requirements for those required to obtain accreditation to conduct asbestos related work in schools, including Inspectors, Management Planners, Project Designers, Contractor/Supervisors and Workers.

In November of 1990, the MAP was amended by the Asbestos School Hazard Abatement Reauthorization Act (ASHARA). The basic intent of ASHARA is to extend many of the AHERA requirements to public and commercial buildings. In addition, ASHARA mandates that the MAP be revised to provide for the extension of accreditation requirements to include certain persons performing asbestos-related work in public and commercial buildings (Federal Register, March 29, 1991). An extension to the effective date for the ASHARA Training Amendments was announced in the Federal Register on January 16, 1992. On May 13, 1992, a Federal Register notice announced EPA's consideration of potential additions and changes to the current MAP. The EPA has most recently made additional changes to the MAP as necessary to implement ASHARA in 1994. These are related to additional practical (hands-on) training requirements for asbestos handlers, supervisors, designers and project monitors.

NESHAP

The Clean Air Act (CAA) of 1970 required EPA to develop and enforce regulations to protect the general public from exposure to airborne contaminants that are known to be hazardous to human health. In accordance with Section 112 of the CAA, the EPA established the National Emission Standards for Hazardous Air Pollutants (NESHAPs). Asbestos was one of the first hazardous air pollutants regulated under Section 112. On March 31, 1971, the EPA identified asbestos as a hazardous air pollutant, and on April 6, 1973, it promulgated the Asbestos NESHAP in 40 CFR Part 61, Subpart M. Since then, the Asbestos NESHAP has been amended several times, most recently in November 1990.

The Asbestos NESHAP is intended to minimize the release of asbestos fibers during activities involving the handling of asbestos. Accordingly, it specifies work practices to be followed during renovations of buildings which contain a certain threshold amount of friable asbestos, and during demolitions of all structures, installations, and facilities (except apartment buildings that have no more than four dwelling units). The Asbestos NESHAP requires action to be taken by the person who owns, leases, operates, controls or supervises the facility being demolished or renovated (the "Owner"), as well as by the person who owns, leases, operates, controls or supervises the demolition or renovation (the "Operator").

The regulations require owners and operators subject to the Asbestos NESHAP to notify delegated State and local agencies and/or their EPA Regional Offices prior to the start of any demolition or renovation activities. The regulations restrict the use of spray asbestos. Materials containing more than 1% asbestos may not be spray-applied unless they are encapsulated with resinous or bituminous binders. In addition, no owner or operator may install wet applied and molded asbestos-containing insulation (pipe lagging). Also regulated by the Asbestos NESHAP is asbestos waste handling and disposal.

The Asbestos NESHAP was amended to clarify existing regulatory policies, and to add regulations which explicitly address monitoring and record-keeping at facilities which mill, manufacture and fabricate asbestos products.

Because of the high risk associated with the transfer and disposal of ACM, the EPA also wanted to strengthen the requirements which govern asbestos waste disposal by implementing tracking and record keeping requirements. Furthermore, the EPA wanted to incorporate the availability of improved emission controls and desired to make the NESHAP consistent with other EPA statues that regulate asbestos.

The following activities and facilities are currently regulated by the Asbestos NESHAP:

- Milling of asbestos.
- Roadways containing asbestos.
- Commercial manufacturing of products that contain asbestos.
- Demolition of all facilities.
- Renovation of facilities that contain friable asbestos.
- The spray application of asbestos.
- Processing (fabrication) of any manufactured products that contain asbestos.
- Use of insulating materials that contain asbestos.
- Disposal of asbestos-containing waste generated during milling, manufacturing, demolition, renovation, spraying and fabricating operations.
- Closure and maintenance of inactive waste disposal sites.
- Operation of and reporting on facilities that convert asbestos-containing waste material into non-asbestos materials.
- Design and operation of air cleaning devices.
- Reporting of information pertaining to process control equipment, filter devices, asbestos generating process, etc.
- Active waste disposal sites.

Under the Asbestos NESHAP, written notification must be made to the regional Asbestos NESHAP contact at least 10 days prior to beginning any work on an asbestos abatement project. In region 2, which includes New York State, the address for this notification is:

Asbestos NESHAP Contract
Air & Waste Management Division
USEPA
26 Federal Plaza
New York, NY 10007
212-264-9500

A sample Asbestos Project Notification Form is attached at the end of this section.

Regarding disposal requirements as specified under the Asbestos NESHAP, there is to be no visible emissions to the outside air during the collection, packaging, transportation or disposal of asbestos containing waste materials. All friable ACM must be wet and sealed in a leak tight container and the containers must be labeled with the appropriate warning labels as specified in the OSHA Asbestos Standard.

Since the NESHAP mandates removal of friable ACM before a building is demolished, the plan for managing ACM should take into account the costs of eventual removal. The same is true for future renovation work covered by NESHAP. It should be noted that certain abatement methods such as encapsulation and enclosure might make eventual removal more difficult and expensive.

40 CFR Part 763, Subpart G EPA WORKER PROTECTION RULE

This regulation extends the OSHA standards to state and local employees who perform asbestos work and who are not covered by the OSHA Asbestos Standards, or by a state OSHA plan. The Rule parallels OSHA requirements and covers medical examinations, air monitoring and reporting, protective equipment, work practices, and record keeping.

OSHA 1910.1001 OCCUPATIONAL EXPOSURE TO ASBESTOS (GENERAL INDUSTRY STANDARD)

The General Industry Standard applies to all occupational exposures to asbestos in all industries covered by the Occupational Safety and Health Act, except exposure to asbestos in construction and maritime work.

Key Definitions

Asbestos is defined under the standard as Chrysotile, Amosite, Crocidolite, Tremolite asbestos, Anthophyllite asbestos, Actinolite asbestos, and any of these minerals that have been chemically treated and/or altered.

The Permissible Exposure Limit (PEL) is established as 0.1 fibers/cubic centimeter over and 8 hour Time Weighted Average (TWA), with an Excursion Limit (EL) of 1.0 fibers/cubic centimeter for a 30 minute average.

Presumed Asbestos Containing Material (PACM) is defined as Thermal System Insulation (TSI) and surfacing materials present in buildings constructed no later than 1980.

A regulated area is an area where airborne concentrations of asbestos exceed or are expected to exceed the PEL. These areas must be demarcated from the rest of the workplace and access limited to trained personnel who must wear respirators when entering the area.

Exposure Monitoring

- Each employer shall perform monitoring to determine airborne concentrations to which each employee in each job classification in each work area may be exposed.
- Breathing zone air samples representative of an 8 hour TWA and 30 minute short-term exposure shall be used.
- 8 hour TWA based on one or more samples representing full shift exposure.
- 30-minute short-term exposures based on one or more samples representing the potentially highest exposure operations.
- Initial monitoring must be performed when an employee is or may be expected to be exposed above the PEL or excursion limit.
- Periodic Monitoring must be performed at least every 6 months and whenever there is a change in a process, control equipment, personnel or work practice.
- All samples must be personal samples which are collected and evaluated with the OSHA Reference Method.
- Results of air sampling must be provided in writing to the affected employees within 15 working days.

Regulated Areas

- Must establish regulated areas wherever airborne concentrations of asbestos or PACM are present which may expose employees in excess of the PEL or Excursion Limit.
- Regulated areas must be demarcated from the rest of the workplace in a manner that minimizes the number of persons who will be exposed.
- Access to regulated areas must be limited.
- Respirators must be supplied to, and worn by all persons entering a regulated area.
- Eating, drinking, smoking, tobacco or gum chewing, or applying cosmetics is prohibited within regulated areas.

Methods of Compliance

- The employer must institute engineering controls and work practices to reduce and maintain employee exposures to or below the PEL where feasible.
- Where engineering controls and work practices are not sufficient or not feasible, respiratory protection must be employed as a supplement.
- Worker rotation cannot be used as a means of compliance.
- Hand operated and power operated tools must be equipped with local exhaust systems.
- Wet methods must be used where practical.
- Compressed air shall not be used to remove asbestos.
- Local exhaust ventilation and dust collection systems must be maintained in accordance with good practices, i.e., ANSI Z9.2-1979.
- A written compliance program must be established to reduce employee exposures. This program must be audited periodically and available to employees.
- The use of negative pressure enclosure/HEPA vacuum system or low pressure/wet cleaning or equivalent methods must be used for brake and clutch repair work.

Respiratory Protection and Protective Clothing/Equipment

- The employer must have a written respiratory protection and personal protective equipment program and must provide all necessary PPE to the employees.

Hygiene Facilities and Practices

- Must include change room, showers, and clean break/lunch areas.

Communication of Hazards

- Building and facility owners must identify ACM or presume materials are ACM (PACM).
- Project bidders, employees and tenants must be notified of the presence, location and quantity of ACM or PACM.
- Following abatement, employees and tenants must be notified of the remaining presence of any ACM and the results of clearance air monitoring.
- All regulated areas must be demarcated with warning signs that can be easily read by employees.
- All products containing asbestos whose handling could cause the PEL to be exceeded must be labeled.
- Training programs and medical surveillance must be provided prior to, or at the time of job assignment, to all employees who may be exposed above the PEL. Records of training, medical surveillance and exposure monitoring must be maintained for a minimum of 30 years.
- Suspect materials must be presumed to be asbestos (PACM) unless rebutted by sampling and analysis in accordance with AHERA procedures.

Housekeeping

- Where vacuuming methods are selected, HEPA filtered vacuum equipment shall be used.
- Asbestos waste, scrap, debris, bags, containers, equipment, and contaminated items consigned for disposal shall be collected and disposed of in sealed, labeled, impermeable bags or containers.

Medical Surveillance

The employer shall provide medical surveillance for all employees exposed to airborne asbestos at or above the PEL. Surveillance includes:

- Pre-placement exam
- Periodic exams (annually)
- Termination of employment exam
- Physicians written opinion
- Information regarding the standard and the workers duties shall be provided to the physician.

Record Keeping

- Personal monitoring data
- Operations involving exposures
- Sampling and analytical methods
- Numbers, durations and results of samples taken
- Names of employees exposed and Social Security numbers
- Objective data for exempted operations
- Medical surveillance
- Training
- Availability of records
- Transfer of records

OSHA 1926.1101 OCCUPATIONAL EXPOSURE TO ASBESTOS (CONSTRUCTION STANDARD)

Definitions

Class I Asbestos Work means activities involving the removal of TSI and surfacing ACM and PACM.

Class II Asbestos Work means activities involving the removal of ACM, which is not TSI or surfacing material.

Class III Asbestos Work means repair or maintenance operations, where ACM is likely to be disturbed.

Class IV Asbestos Work means maintenance and custodial activities during which employees contact ACM and PACM and activities to clean up waste and debris containing ACM and PACM.

Competent Person is a person capable of identifying and selecting controls for asbestos hazards, and who has authority to take corrective action. Also one who possesses 5 days of training (i.e. Asbestos Contractor Supervisor certification) for Class I and II asbestos work and at least O&M certification for Class III and IV asbestos work.

Presumed Asbestos Containing Material (PCAM) is defined as Thermal System Insulation (TSI) and surfacing materials present in buildings constructed no later than 1980.

A *Regulated Area* is an area where airborne concentrations of asbestos exceed or are expected to exceed the PEL. These areas must be demarcated from the rest of the workplace and access limited to trained personnel who must wear respirators when entering the area.

Exposure Monitoring must be performed to determine the airborne concentrations to which each employee in each job classification in each work area may be exposed.

Initial Monitoring must be performed when an employee is or may be expected to be exposed above the PEL.

Periodic Monitoring must be performed at sufficient intervals and whenever there is a change in a process, control equipment, personnel or work practice. All samples must be personal samples and results must be provided in writing to the affected employees within 15 working days.

Required Steps if Permissible/Excursion Limit Exceeded

- Medical surveillance if level exceeded 30 days or more per year.
- Medical surveillance if employee is required to wear a respirator.
- Daily personal air monitoring.
- Notification of air monitoring results ASAP
- If PEL is exceeded, inform employees of corrective actions to be taken.

Exposure Levels Above PEL/Excursion Limit

- Establish regulated area.
- Limit access.
- Provide respirators to all persons entering area.
- Prohibit eating, smoking, drinking, chewing tobacco or gum, and applying cosmetics.
- Establish negative pressure enclosure if feasible.
- Designate competent person.

Competent Person

- Provides frequent and regular inspections of job sites.
- Class I jobs require inspections during each work shift and at employee request.
- Class I and II jobs require a competent person to perform or supervise containment set up and integrity checks, conformance with PPE requirements, proper hygiene facility use, proper work practices and engineering controls are used and that notification requirements are met.
- Training requirements for competent person are equivalent to supervisor training.

Regulated Areas

- Airborne levels of asbestos fibers may exceed the PEL.
- Include all Class I, II, and III areas.
- Must be isolated to restrict access.
- All persons within the area must wear respirators.

Exposure Assessment Via Air Monitoring

- Each employer shall perform monitoring to accurately determine airborne concentrations to which employees may be exposed.
- Breathing zone air samples representative of 8 hour TWA and 30 minute short-term exposures shall be used.
- 8 hour TWA based on one or more samples representing full shift exposure.
- 30 minute short term exposures based on one or more samples representing potentially high exposure operations.
- Initial monitoring shall be performed at the start of each job.
- Daily monitoring shall be performed which is representative of exposure to each employee.
- Employer shall notify affected employees of all monitoring results ASAP.
- Affected employees must be granted the opportunity to observe any monitoring.
- Objective demonstration of consistent exposures “closely resembling” actual exposures.
- Monitoring is required unless positive pressure supplied air respirators are used or if a “negative exposure assessment” is obtained.

Methods of Compliance/Engineering Controls & Work Practices

Employer shall use the following regardless of the level of exposure:

- HEPA filtered ventilation systems and vacuum cleaners.
- Wet methods.
- Prompt clean up and disposal of asbestos containing wastes.

Employer shall use the following to comply with PELs:

- Enclosure or isolation of source.
- General ventilation that draws air from the breathing zone and HEPA filters it.
- Any additional work practices the Assistant Secretary can show to be feasible.
- Respirators and protective equipment when engineering controls and work practices are not sufficient.

Prohibitions:

- Power tools not equipped with HEPA filters.
- Use of compressed air.
- Employee rotation for exposure control
- Dry sweeping or shoveling.

Class I Areas:

- Exposure assessment.
- Competent person supervision.
- Work practices.
- If negative exposure assessment (NEA) not produced, must use critical barriers, perimeter monitoring, isolate HVAC, negative pressure enclosures, enclosure inspections, deactivated electrical circuits or GFCI, glove bag and glove box procedures or water spray processes.

Class II Areas:

- Exposure assessments.
- Competent person supervision.
- If negative exposure assessment (NEA) not produced for indoor jobs, must use critical barriers, perimeter monitoring, isolate HVAC, negative pressure enclosures, enclosure inspections, deactivated electrical circuits or GFCI, glove bag and glove box procedures or water spray processes.
- Floor covering removal controls and work practices.
- Roofing material removal controls and work practices.
- Transit materials removal controls and work practices.
- Gasket removal controls and work practices.
- Other control methods can be used if they are designed and certified by a competent person and they perform adequately.

Class III Areas:

- HEPA filtered ventilation systems.
- Wet methods.
- Mini-enclosures or glove bags.
- Impermeable drop cloths and plastic barriers.

- If “negative exposure assessment” not produced, must have respiratory protection program.

Class IV Areas:

- Trained employees (asbestos awareness minimum).
- HEPA filtered vacuum cleaners.
- Wet methods.
- Prompt clean up and disposal of asbestos containing wastes.
- Must have respiratory protection program.

Respiratory Protection

- Employers shall select and provide appropriate respirators during all Class I jobs, Class II jobs when ACM is not intact, Class II & III jobs not using wet methods or having a NEA, Class III jobs where TSI or surfacing material is being removed, when exposures exceed the PEL and in emergencies.
- A respiratory protection program must be instituted as follows:
 1. Must conform to 29 CFR 1910.134.
 2. Filters changed when increase in breathing resistance detected.
 3. Employees permitted to leave work areas to wash faces and/or face pieces.
 4. Employees must be able to function normally in job assignment.
 5. Fit tests shall be performed at time of initial fitting and annually thereafter.

Protective Clothing

- Employer shall provide and require the use of appropriate protective clothing if the PEL is exceeded, there is no NEA, or in Class I jobs exceeding removal of 25 linear feet or 10 square feet of TSI or surfacing material.
- Informed laundering shall be performed in a manner that prevents the release of airborne asbestos fibers.
- Contaminated clothing shall be transported in labeled, sealed bags or containers.
- The Competent Person shall examine employee work suits for rips and tears at least once per shift. Such rips and/or tears shall be immediately mended, or the work suit replaced.

Hygiene Facilities & Practices

- Employers shall provide Decontamination areas for all Class I jobs exceeding removal of 25 linear feet or 10 square of TSI or surfacing materials.
- The Decontamination area consists of an equipment room, shower area, clean change room and proper decontamination procedures. Clean lunch/break room if consumption occurs on the worksite.
- Employees may clean protective clothing using HEPA vacuum and use a remote decon when the work is outdoors or adjacent decon is not feasible.

- Employee shall provide equipment room, entry and exit procedures, waste out procedures and control visible contamination for all Class I jobs where removal of less than 25 linear feet or 10 square feet of TSI or surfacing material takes place.

Communication of Hazards

- Building and facility owners must identify ACM or presume materials are ACM (PACM).
- Project bidders, employees, and tenants must be notified of the presence, location and quantity of ACM or PACM.
- Following abatement, employees and tenants must be notified of the remaining presence of any ACM and the results of clearance air monitoring.
- All regulated areas must be demarcated with warning signs that can be easily read by employees.
- All products containing asbestos whose handling could cause the PEL to be exceeded must be labeled.
- Training programs and medical surveillance must be provided prior to, or at the time of job assignment, to all employees who may be exposed above the PEL. Records of training, medical surveillance and exposure monitoring must be maintained for a minimum of 30 years.
- Suspect materials must be presumed to be asbestos (PACM) unless rebutted by sampling and analysis in accordance with AHERA procedures.

Housekeeping

- Where vacuuming methods are selected, HEPA filtered vacuum equipment shall be used.
- Asbestos waste, scrap, debris, bags, container, equipment, and contaminated items consigned for disposal shall be collected and disposed of in sealed, labeled, impermeable bags or containers.
- Procedures for ACM flooring including no sanding finish stripping while wet (low abrasion pads run at less than 300 RPM).

Medical Surveillance

Employees covered by medical surveillance include:

- Employees engaged in Class I, II, and III work or are exposed to fiber levels greater than the PEL or the excursion limit for 30 days or more per year.
- All employees required wearing negative pressure respirators.

Examinations must be performed by or under the supervision of a licensed physician, at no cost to the employee and at a reasonable place and time.

- Pre-placement (initial) exam
- Periodic exams (annually)
- Termination of employment exam

- Information regarding the standard and the workers duties shall be provided to the physician

Examinations must include:

- Medical and work history
- OSHA standardized questionnaires
- A physical examination (pulmonary and gastrointestinal), with chest x-ray
- Pulmonary function test
- Physicians written opinion

Record Keeping

Records must be maintained for at least 30 years and must include:

- Objective data for exempted operations
- Exposure assessments
- Medical surveillance
- Training records
- PACM rebuttals
- Required notifications
- Availability of records to the Assistant Secretary
- Transfer of records

DOT HAZARDOUS SUBSTANCES 49CFR Part 171 & 172

The Department of Transportation requires the placarding of vehicles carrying more than 1001 pounds of any hazardous substance. Asbestos products and asbestos waste are classified as Class 9 hazardous materials. Vehicles transporting these materials must display the proper placard for hazard class 9 and the ID number for the material.

NESHAP SUMMARY

	DEMOLITION		RENOVATION	
Amount	≥ 260 ft or ≥ 160 ft ² or ≥ 35 ft ³	< 260 ft or < 160 ft ²	≥ 260 ft or > 160 ft ² or ≥ 35 ft ³	< 260 ft or < 160 ft
Notification	YES	YES MODIFIED	YES	NO
How Far in Advance	10 DAYS	20 DAYS	EARLY AS POSSIBLE BEFORE	
Emission Controls	YES	NO	YES	NO
Disposal Standard	YES	NO	YES	NO

NEW YORK STATE REGULATIONS

Of the New York State regulations listed above which pertain to asbestos, the two key regulations are Code Rule 56 and the accreditation of training programs. These regulations are summarized below.

INDUSTRIAL CODE RULE 56 12 NYCRR PART 56

Purpose and Intent

Reduce risks to the public associated with exposure to asbestos.
Conforms to Federal requirements set forth in AHERA, NESHAPs, and the OSHA Construction Standard.

Define standards and procedures for installing, removing, enclosing, applying, encapsulating or disturbing asbestos-containing materials.

Application

- Throughout New York State
- Does not apply to the manufacturing of asbestos or asbestos materials, or to manufacturing processes involving the use of asbestos.
- Also, does not apply to the owner of an owner-occupied single family home, where the owner does the work

Key Definitions

Asbestos Material: Any material containing more than 1% asbestos.

Asbestos Project:

Large Project: 260 linear feet or 160 square feet or greater

Small Project: Less than 260 linear feet or 160 square feet
Greater than 25 linear feet or 10 square feet

Minor Project: Less than or equal to 25 linear feet or 10 square feet

**NEW YORK STATE DEPARTMENT OF HEALTH
ASBESTOS SAFETY PROGRAM
PART 73 OF 10 NYCRR**

Purpose

Specifies the terms and conditions under which training programs must be designed to certify asbestos handlers and thereby minimize exposure of the public.

Application

All workers who apply for State certification to work on asbestos projects in New York State.

Key Definitions

Approved asbestos safety program: A program approved by the Commissioner of Health providing training in the handling and use of asbestos and asbestos material, education concerning safety and health risks inherent in such handling and use, and training in techniques for minimizing the exposure of the public to asbestos fibers, which shall include but not be limited to instruction in all applicable Federal, State and local laws and regulations.

Asbestos Handler: An individual, who removes, encapsulates, repairs, or encloses asbestos or asbestos material or who disturbs friable asbestos.

Asbestos Project: Work undertaken by a contractor which involves the installation, removal, encapsulation, application or enclosure of any asbestos material or the disturbance of friable asbestos, except for work in an owner occupied single-family dwelling performed by the owner of such dwelling. Where all asbestos work on a project is subcontracted to a contractor with an asbestos handling license, only that part of the work involving asbestos shall be deemed to be an asbestos project.

- Basic Core Course for Asbestos Handler
- Operation and Maintenance
- Restricted I – Allied Trades
- Restricted II – Air Sampling Technician
- Restricted III - Inspector
- Project Monitor
- Contractor/Supervisor
- Management Planner
- Project Designer

SECTION 5 PERSONAL PROTECTIVE EQUIPMENT

INTRODUCTION

Personal protective equipment (PPE) is worn to prevent gross amounts of asbestos from coming in contact with the skin, eyes and ultimately, the respiratory system. It provides a barrier, protecting workers from the harmful effects of asbestos exposure on the skin (which may result in asbestos warts) or within the respiratory system. In addition to asbestos, many other irritating materials may also be present at the site, such as mineral wool, fiberglass and various solvents and cleaners. Along with engineering controls and carefully planned work practices, protective equipment is a key element in minimizing the potential for exposure to all of these hazards.

The use of protective equipment is not a substitute for engineering controls, good work practices, personal hygiene or good planning. In addition, employers who assign personal protective equipment must have a written PPE program as required under the OSHA Personal Protective Equipment Standard.

SELECTION

In selecting PPE, the ultimate use must be kept in mind. If the user will not physically stress the PPE or allow it to become heavily contaminated (eg, entering a worksite to conduct a brief inspection), a less durable or less expensive item might be used. Alternately, if extreme physical activities are anticipated, such as abatement work, the most durable item should be selected. Other factors to consider include:

- Communications
- Decontamination
- Heat stress
- Work Activity
- Duration of exposure

INSPECTION

PPE should always be inspected immediately upon receipt. The following steps should be taken:

- **Verify** the type of material is that which was ordered.
- **Visually inspect** the item for imperfections, pinholes, (light test) non-uniform coatings, etc.

PPE should be inspected by the worker prior to use. The wearer should be familiar with the proper use and limitations of the PPE. Proper size should be selected and all closures (eg, zippers) should be checked (use the buddy system).

COVERALLS

Typically, disposable coveralls of polyolefin or polypropylene fabrics are used in asbestos abatement projects. While this is the normal practice, it is not required. Reusable coveralls can be used, with the provision for proper laundering. While disposable clothing is the most widely used body covering in the abatement industry, there are advantages and disadvantages to the use of each type. In either case, no personal clothing can be worn under the coverall, with the exception of nylon bathing suits. Disposable underwear is also available as an optional garment.

HOODS

Abatement workers must wear a hood that is either attached to the coverall or is added to the ensemble and taped on. The purpose of wearing a hood is to prevent gross amounts of asbestos fibers from contaminating the hair and scalp.

It should be noted that wearing a hood does not exempt abatement workers from thoroughly washing hair during the decontamination process.

FOOTWEAR

As with hoods, coveralls frequently come with attached booties. Separate booties are available to use in conjunction with those coveralls not equipped with booties. They may also be used as re-enforcement of coverall booties. In addition to booties, other footwear is necessary to protect the feet from injury. Approved safety shoes or boots should be used. Frequently, inexpensive sneakers are selected instead of approved safety shoes when conducting certain types of abatement projects (eg, floor tile mastic). These sneakers are then disposed of at the end of the abatement project, minimizing the need for decontamination.

GLOVES

Protective hand coverings are also required. Depending on the type of abatement work, fabric, rubber or chemically resistant materials may be selected. Wrists must be taped to the coveralls to prevent asbestos fibers and other contaminants from entering the coveralls at the sleeves.

EYE PROTECTION

When wearing half-face respirators, eye protection should be worn. Depending on the individual and the brand of respirator, either safety glasses or goggles may be worn. Eye protection, like other forms of PPE should be regularly inspected. If the lenses are scratched, cracked or otherwise damaged, or the frame is damaged or misshapen, the eyewear should be discarded or repaired with original replacement parts.

Protective eyewear should be issued to, and treated by the employee in the same manner as a personally issued respirator. Cleaning and sanitizing the eyewear is the responsibility of the employee.

HARD HATS

Hard hats are designed to provide a limited degree of protection to the head. Only hard hats meeting the specifications of ANSI should be worn on abatement projects. Hard hats should be issued to the employee as a personally assigned item. If reassigned, the hat must be sanitized and a new, clean suspension installed.

As with other protective devices, hard hats should be inspected for damage to the body and the suspension system. Damaged parts should be replaced with original replacement parts or the entire hat discarded and replaced.

HEARING PROTECTION

In high noise areas, hearing protection must be worn. Many types of protectors are available, however, these can be divided into two categories:

1. Those fitting into the ear canal, such as foam plugs or caps.
2. Those covering the ear, such as “muffs”.

AIR PURIFYING RESPIRATORS

Respirators are used when the airborne concentration of a contamination is high enough to cause some type of health effect. This may range from irritation to systemic damage or even death. Air purifying respirators are prohibited to be used in an IDLH atmospheres or oxygen-deficient atmospheres. The basic function of a respirator is to reduce the risk of respiratory injury due to breathing such contaminants. Air purifying respirators (APRs) accomplish this by removing contaminants from the ambient air by one of two methods; filtering or absorbing the contaminants.

All respirators have in common two main parts; (1) the device which purifies the air, and (2) the facepiece that covers the nose and/or mouth to deliver clean air and seal out contaminants.

Air Purifying Elements

APRs remove contaminants by passing the breathing air through a purifying element. These elements fall into two categories:

1. Mechanical filters
2. Chemical sorbents

Mechanical Filters

Mechanical filters are classified according to the protection for which they are approved. These classes are as follows:

1. Dusts and Mists TLV equal to or greater than 0.05 mg/m³.
2. Dusts, Mists and Fumes – TLV equal to or greater than 0.05 mg/m³
3. Dusts, Mists and Fumes – TLV less than 0.05mg/m³, also known as a HEPA or High Efficiency Particulate Air Filter (NIOSH rating of 100).

Mechanical filters can be used until breathing becomes restricted by the build-up of particles. They actually become more efficient as they load up.

Chemical Sorbents

Chemical sorbent filters are designed to absorb or neutralize gases as they pass through the filter element. Various sorbent materials are used. The proper sorbent must be chosen based on the type of contaminant present. The most commonly used sorbent is activated carbon. This makes up the heart of organic vapor respirator cartridges.

Sorbent elements have a finite capacity to remove contaminants. When this limit (service life) is reached, the element is said to be saturated. Once saturation has occurred, contaminants will begin to pass through the element and enter the facepiece. At this point, breakthrough is said to have occurred.

Service life of sorbents is dependent on a number of factors including:

- Breathing rate
- Contaminant concentration
- Sorption efficiency
- Chemical being absorbed
- Humidity
- Volume of sorbent

Cartridge Selection

All manufacturers follow the same color coding system for identifying respirator cartridges as follows:

- Acid Gases – White
- Organic Vapors – Black
- Acid Gases & Organic Vapors – Yellow
- Ammonia/Methylamine – Green
- Dusts, Fumes and Mists – Orange
- Dusts, Fumes, Mists & Radionuclides – Purple (Magenta)
- Acid Gases, Ammonia, and Organic Vapors – Brown
- Other Vapors and Gases (not listed above) – Olive
- Combination with Dusts, Fumes, Mists & Radionuclides – Purple Stripe
- Combination with Dusts, Fumes and Mists (other than radioactive) – Orange Stripe

Although filters and cartridges are color-coded, the best method used to identify the filter or cartridge is by reading the label on the filter or cartridge.

Respirator Selection

The protection provided to the wearer is a function of how well the facepiece fits. No matter how efficient the purifying element is, there is little protection afforded if the respirator does not provide a leak-free facepiece-to-face seal.

Not all respirators fit everyone, but with the large variety of respirators available, at least one type should be found which will fit a particular individual. In addition, selection of the proper respirator for an individual should be made on the relative comfort of the fit. This can only be determined by wearing a respirator for a period of time.

In general, selection of the proper respirator depends on the following:

- The nature of the hazard.
- The characteristics of the hazardous operations or process.
- The location of the hazardous area with respect to a safe area having respirable air.
- The period of time for which respiratory protection must be provided.
- The activity of workers in the hazardous area.
- The physical characteristics, functional capabilities and limitations of respirators of various types.
- The respirator protection factor and fit.

Fit Testing

Certain conditions will prevent a good respirator seal. Among them are:

- Facial hair
- Make-up
- Eyeglasses
- Missing teeth or dentures
- Facial scars

Since respirators function by producing a negative pressure in the facepiece, a good seal is essential. Respirator users must pass a fit test to ensure that the selected respirator will provide a good seal. Fit tests must be performed initially (ie, prior to use in a work area where respiratory use is required), annually, or following any significant weight gain/loss or oral/facial surgery.

Qualitative fit testing is not an analytical measurement. It is a subjective test to determine if there is a good face-to-face piece seal by exposing the wearer to a “test agent” (eg, irritant smoke or Isoamyl Acetate). If the subject does not detect the challenge substance, the fit is acceptable.

Quantitative fit testing is an analytical method of measuring the fit of a particular respirator by actually measuring the concentration of a contaminant both inside and outside the respirator while being worn in a controlled test atmosphere.

Types of Respirators

1. Half-face with twin mounted cartridges or filters
2. Full-face with twin mounted cartridges or filters
3. Powered Air Purifying Respirators (PAPRs) with cartridges or filters
4. Supplied Air Respirators (SARs)

Protection factors assigned by OSHA are as follows:

- Half-face = 10 x
- Full-face = 50 x
- PAPR = 1,000 x
- SAR/Continuous Flow = 10,000 x

These protection factors may have a different value if so stated by the manufacturer.

The protection factor (PF) is calculated as follows:

$$PF = \frac{\text{Concentration Outside Mask}}{\text{Concentration Inside Mask}}$$

The maximum use for each type of respirator can be calculated using the following formula: $APF \times PEL = MUC$

The maximum use for each type of respirator is calculated below, using the PEL for asbestos (ie, 0.1 f/cc)

- Half-face – $10 \times PEL = 1.0 \text{ f/cc}$
- Full-face – $50 \times PEL = 5.0 \text{ f/cc}$
- PAPR – $1,000 \times PEL = 100.0 \text{ f/cc}$
- SAR/Continuous Flow – $10,000 \times PEL = 100.0 \text{ f/cc}$

Function

The facepiece seals the respirator to the wearer. As previously stated, this seal is critical since the respirator functions by creating a negative pressure inside the mask. An inadequate seal will allow the contaminants to bypass the filter element and directly enter the mask, since a direct route will be the route of least resistance.

Attached to the facepiece is a lens of a polycarbonate material (full-face only), and a suspension system to hold the mask to the face. Cartridges are attached to the facepiece by cartridge adapters. Within the adapter is a check valve, which allows air to enter, but prevents exhaled air from exiting back through the filter element. A separate exhalation valve in the facepiece prevents unfiltered air from entering the respirator and allows exhaled air to exit. Some respirators also incorporate an air-tight speaking diaphragm to improve the ability of the wearer to communicate.

Each respirator manufacturer must provide a unique system of attaching each part of the respirator and filter elements to prevent any possibility of hybridizing parts.

Options

There are many options, which should be considered when selecting a respirator. Various brands and styles are available which may appear to have advantages or liabilities depending on the application and individual making the selection. Among these considerations are:

- Number of suspension points.
- Ratchet vs. conventional adjustment.
- Speaking diaphragm.
- Number of seals.
- Sweat drain holes.
- Materials of construction.
- Size of lens area.
- Ability to convert to supplied air.
- Filter element selection and design.
- Availability of filter elements and replacement parts.

Respirator Approval

Only respirators approved by NIOSH/MSHA shall be used. As of 1996, NIOSH is the only respirator approval agency in the United States; therefore, newly manufactured respiratory protection products will bear only the NIOSH approval stamps.

New Developments

Half-face – Recently, new types of respirators have been introduced by several manufacturers. These new types include both limited use and disposable respirators. In appearance, these respirators look much the same as a traditional half-face respirator, however, the cartridges may be permanently attached and not replaceable, or the unit may be designed of only a limited number of uses (low or no maintenance).

The prime advantages of these types of respirators are; (1) the convenience of not having to decontaminate or clean it, (2) low or no maintenance, and (3) light weight/comfort. However, the cost of these respirators makes them significantly more expensive over extended periods of use than traditional respirators with replaceable cartridges.

Full Face – An increasing number of manufacturers are offering 100% silicone or silicone composite respirators. These respirators provide a significant increased level of comfort and fit due to their added flexibility. Costs are generally 10% to 20% greater than the traditional neoprene rubber respirators. It should be noted that these respirators can be sanitized with alcohol based wipes without degradation of the facepiece material. Low cost materials such as polyurethane have also been introduced.

TYPE C SUPPLIED AIR RESPIRATORS & SELF CONTAINED BREATHING APPARATUS

Airline systems - Supplied air respirators, which deliver air to the user from a remote location (up to 300 feet) either from a compressor or a bank of compressed air cylinders. The air may flow continuously (continuous flow), or as the wearer breathes (demands) it. When demand respirators are used, they must be positive pressure type (pressure/demand). The air source must not be depletable and an escape device (HEPA filter asbestos abatement work) must be provided. The respirator may be a facemask or an air hat/hood.

Escape Respirators – These systems provide a minimum of 5 to 15 minutes of air to the user and are designed for escape only. The escape air supply is in-line with an airline system.

The supply reservoir may be a cylinder (high or low pressure) or a high-pressure tubing system. They may be controllable or automatic. Escape systems are required only in IDLH (immediately dangerous to life and health) atmospheres, and are not typically used in asbestos abatement projects.

Self-contained systems – self-contained breathing apparatus (SCBAs) consist of a facepiece and regulator mechanism connected to a cylinder of compressed air or oxygen carried by the wearer. The advantage of the SCBA is that they allow the wearer to work without being confined by a hose or airline. Additionally, the units are able to be quickly put into use. Due to the high cost of purchasing and operating SCBAs, and the limitations on air supply, they are not commonly used in abatement work.

A comprehensive discussion of respiratory protection is included at the end of this section in a USEPA publication entitled “A Guide to Respiratory Protection for the Asbestos Abatement Industry”.

OTHER PERSONAL PROTECTIVE EQUIPMENT

Site-specific operations may require the use of specialized protective equipment such as full body harnesses, safety lanyards, welding goggles, etc. Where these are used, workers must be trained in the proper use, maintenance and limitations of these devices prior to work assignment. Difficulty in decontaminating these items may require their disposal following the conclusion of the project.

DONNING/DOFFING

Personal protective equipment should be donned on the “clean” side of the decontamination facility. The procedure to be used is as follows:

1. **Street clothes**, including undergarments, should be removed and stored in a clean location. Jewelry, watches and rings should be removed and placed in a secure area.
2. **Coveralls**, gloves and boots are then donned, and taped at the wrist and ankle. Use of coveralls with attached booties eliminates the need to tape ankles, however, taping may still be advisable to prevent booties from becoming loose, resulting in trip hazards. Waists may also be taped to provide an acceptable fit. If desired, the crotch, shoulders or other stress points may be taped to reinforce the seam.
3. **Respirator** is then donned and checked by the positive/negative fit check procedure.
4. **Coverall hood** is then placed over the respirator head straps, and secured with a tie or tape.
5. **Other protective equipment**, such as hard hats and eye protection are then donned.

When leaving the work area, personnel must pass through the decontamination facility by the following procedure:

1. **Remove protective clothing (except respirator)** in the first chamber of the decontamination facility.
2. **Disposable clothing is discarded** as asbestos containing waste. Reusable equipment is cleaned.
3. **Enter the shower** and thoroughly shower while wearing the respirator. The respirator cartridges should be thoroughly wetted. The respirator can then be removed and washed off inside as well.
4. **Following decontamination**, personnel exit to the clean room and disinfect the respirator and redress in street clothes.

STORAGE

PPE should be kept in clean, dry areas and separated by size. Inspections upon receipt and after each use will ensure that PPE will be ready for immediate use when needed.

SUMMARY

PPE, properly used, provides a limited amount of protection to the abatement worker. It should not be considered a substitute for proper decontamination, personal hygiene or as an invitation to take chances. Combined with the proper respiratory protection, common sense and safe work practices, exposure to asbestos and other hazards can be reduced to acceptable limits.

RESPIRATOR PROGRAM CHECKLIST

In general, the respirator program should be evaluated for each asbestos abatement job or at least annually with program adjustments, as appropriate, made to reflect the evaluation results. Program function can be separated into administration and operation.

A. Program Administration

- _____ (1) Is there a written policy which acknowledges employer responsibility for providing a safe and healthful workplace, and assigns program responsibility, accountability, and authority?
- _____ (2) Is program responsibility vested in one individual who is Knowledgeable and who can coordinate all aspects of the program at the job site?
- _____ (3) Can feasible engineering controls or work practices eliminate the need for respirators?
- _____ (4) Are there written/statements covering the various aspects of the respirator program, including:
 - _____ designation of an administrator;
 - _____ respirator selection;
 - _____ purchase of approved equipment;
 - _____ medical aspects of respirator usage;
 - _____ issuance of equipment;
 - _____ fitting;
 - _____ training;
 - _____ maintenance, storage, and repair;
 - _____ inspection;
 - _____ use under special conditions; and
 - _____ work area under surveillance?

B. Program Operation

(1) RESPIRATORY PROTECTIVE EQUIPMENT SELECTION

_____ Are work area conditions and worker exposures properly surveyed?

_____ Are respirators selected on the basis of hazards to which the worker is exposed?

_____ Are selections made by individuals knowledgeable of proper selection procedures?

_____ (2) Are only approved respirators purchased and used, do they provide adequate protection for the specific hazard and concentration of the contaminate?

_____ (3) Has a medical evaluation of the prospective user been made to determine physical and psychological ability to wear the selected respiratory equipment?

_____ (4) Where practical, have respirators been issued to the users for their exclusive use, and are there records covering issuance?

(5) RESPIRATORY PROTECTIVE EQUIPMENT FITTING

_____ Are the users given the opportunity to try on several respirators to determine whether the respirator they will subsequently be wearing is the best fitting one?

_____ Is the fit tested at appropriate intervals?

_____ Are those users who require corrective lenses properly fitted?

_____ Are users prohibited from wearing contact lenses when using respirators?

_____ Is the facepiece-to face seal tested in a test atmosphere?

_____ Are workers prohibited from entering contaminated work areas when they have facial hair or other characteristics which prohibit the use of tight-fitting face-pieces?

(6) RESPIRATOR USE IN THE WORK AREA

_____ Are respirators being worn correctly (i.e., head covering over respirator straps)?

_____ Are workers keeping respirators on all the time in the work area?

_____ Are workers wearing respirators into the shower without disturbing the face fit?

(7) MAINTENANCE OF RESPIRATORY PROTECTIVE EQUIPMENT

Cleaning and Disinfecting

_____ Are respirators cleaned and disinfected after each use when different people use the same device, or as frequently as necessary for devices issued to individual users?

_____ Are proper methods of cleaning and disinfecting utilized?

Storage

_____ Are respirators stored in a manner so as to protect them from dust, sunlight, heat, excessive cold or moisture, or damaging chemicals?

_____ Are respirators stored properly in a storage facility so as to prevent them from deforming?

_____ Is storage in lockers and tool boxes permitted only if the respirator is in a carrying case or carton?

Inspection

_____ Are respirators inspected before and after each use and during cleaning?

_____ Are qualified individuals/users instructed in inspection techniques?

_____ Is respiratory protective equipment designated as “emergency use” inspected at least monthly (in addition to after each use)?

_____ Is a record kept of the inspection of “emergency use” respiratory protective equipment?

Repair

_____ Are replacement parts used in repair those of the manufacturer of the respirator?

_____ Are repairs made by manufacturer or manufacture-trained individuals?

(8) SPECIAL USE CONDITIONS

_____ Is a procedure developed for respiratory protective equipment usage in atmospheres immediately dangerous to life or health?

_____ Is a procedure developed for equipment usage for entry into confined spaces?

(9) TRAINING

- _____ Are users trained in proper respirator use, cleaning, and inspection?
- _____ Are users trained in the basis for selection of respirators?
- _____ Are users evaluated, using competency-based evaluation, before and after training?

SECTION 6 DECONTAMINATION SYSTEMS

INTRODUCTION

Essential elements of any asbestos abatement project are facilities and procedures for personnel, equipment and waste decontamination. Depending on the size of the project, specifically designed facilities must be provided. These facilities may, and generally are, constructed on site. However, prefabricated, knock-down facilities are available, as well as trailer mounted, ready-to-go facilities.

The decontamination facility is designed to prevent the spread of asbestos-containing dust outside the work area by directing all clothing, equipment, waste and personnel through a carefully planned sequence of decontamination. When combined with the use of negative ventilation equipment inside the containment area, the decontamination system promotes the direction of airflow from a “clean” area to a “dirty” area. This further reduces the potential for fugitive asbestos emissions that might contaminate adjacent spaces.

ESTABLISHING DECONTAMINATION UNITS

The Personal Decontamination System

Under most circumstances, personal decontamination systems must be outside and attached to all locations where personnel are to enter or exit a work area. A typical system consists of a clean room, a shower room and an equipment room in series, separated from each other and the work area by specially designed airlocks. On occasion, existing rooms adjacent to the work area can be modified to serve as decontamination facilities. However, under most circumstances, an enclosure system will have to be fabricated from metal, wood and plastic materials. Some of the materials used to construct a typical unit may include:

- 2"x4" framing lumber
- Plywood sheeting
- 6 ml fire-retardant plastic sheeting for walls and roof
- 6 ml fire-retardant reinforced plastic sheeting for the floor*
- Duct tape, nails, staples and spray-glue

* The floor should be covered with at least two layers of 6 ml fire retardant reinforced plastic sheeting.

The decontamination unit may be built in sections to allow for disassembly and be reused at another area of the building. The actual design of this system will vary with each project depending on the size of the workforce and the physical constraints imposed by the facility. Regardless of the style, all units must incorporate adequate security measures to prevent unauthorized entry. Prefabricated or customized decontamination trailer units may also be used (see Figure 6-1).

Whether or decontamination unit is constructed on site or is in the form of a trailer, the basic design remains the same. The arrangement of the chambers allows for a sequential process of decontamination, starting at the “dirty” end and finishing at the “clean” room. The major components and their uses are discussed below.

FIGURE 6-1

**PERSONAL DECONTAMINATION SYSTEM ENCLOSURE
LARGE ASBESTOS PROJECT (OPTIONAL FOR SMALL ASBESTOS PROJECT)**

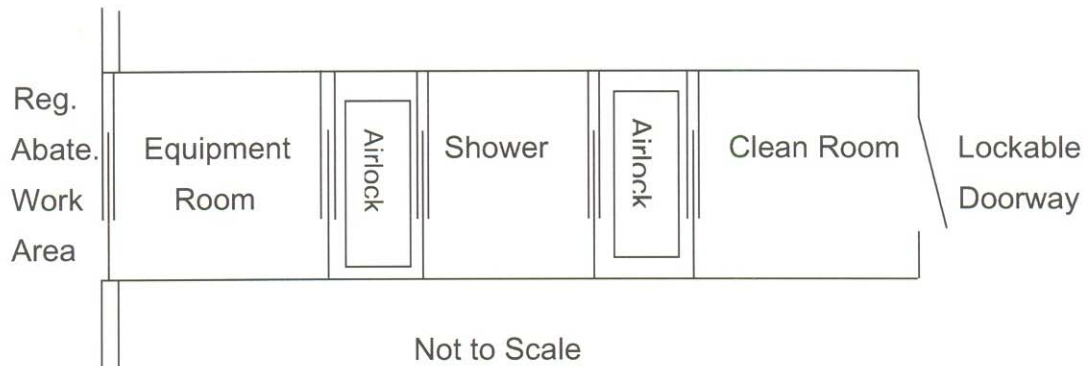

Decontamination Trailer

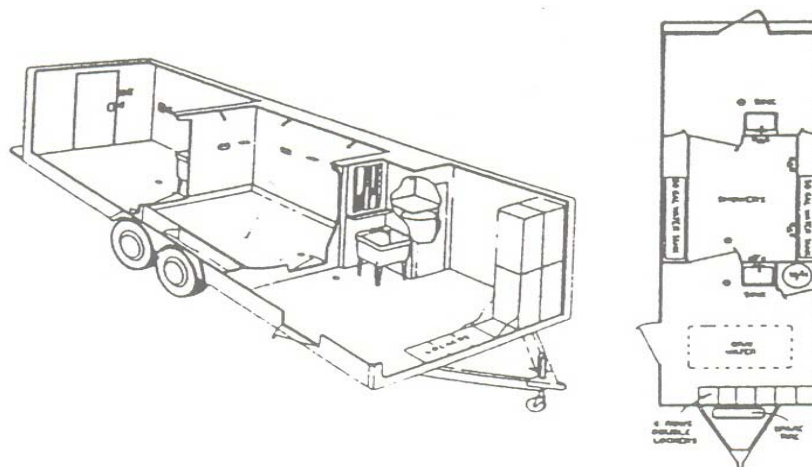

Compliments of Control Resource Systems, Inc.

The Clean Room

No asbestos-contaminated items should enter this room. Abatement personnel and authorized visitors use this area to remove and store street clothes, don personal protective clothing and respiratory protection prior to entering the work area. Upon exiting the work area, this room is used to dress in clean clothes after following proper decontamination procedures. Ideally, the clean room should be furnished with benches, lockers for clothes and valuables as well as various hooks and shelves for respirator storage (in NYS, refer to Industrial Code Rule 56 for specific regulations). Additional items such as clean coveralls, replacement respirator filters, towels and other necessary items should be stored in this room for easy access.

The clean room should not be used for the storage of tools, equipment, abatement supplies or as office space. Separate areas, near the decontamination unit, should be designated for these purposes. A lockable door should be installed at the main entrance to provide security during off-shift hours.

An entry/exit log must be provided in the clean room. All personnel who enter or exit the work area must sign this log upon every entry and exit. The purpose of the log is twofold:

1. The signature on the log documents that each person entering the work area has reviewed and understands the posted regulations, personal protection requirements and emergency procedures.
2. In the event of an emergency, the log is necessary to account for all personnel who are in the work area. Following a site emergency, the site supervisor will use the log to check that all personnel have safely exited the work area.

The Shower Room

Workers pass through the shower room on their way to the removal area, and use the showers on their way out after leaving contaminated clothing in the equipment room. For projects performed in New York State, there must be one shower per six full shift abatement persons (calculated on the basis of the largest shift). Refer to NYS Industrial Code Rule 56 for complete details. Each showerhead must be supplied with hot and cold water adjustable at the tap. Uncontaminated soap, shampoo, and towels must also be readily available.

Shower wastewater should be collected and treated as asbestos-contaminated material or filtered through a system with at least 5.0-micron particle size collection capability. Filtered wastewater must be discharged in accordance with all applicable codes.

The Equipment Room

This is a contaminated area where equipment, boots or shoes, hardhats, goggles, and any additional contaminated work clothes are stored after proper HEPA and/or wet cleaning. Workers place disposable clothing such as coveralls, booties, and hoods in bins (labeled and lined with a six mil. plastic bag) before leaving this area for the shower room. In addition to the above items, a one day supply of replacement filters for HEPA vacuums and negative pressure ventilation units should be kept in sealed containers for future use.

A walk-off pan filled with water should be located in the work area just outside the equipment room for personnel to clean foot coverings when leaving the work area. The equipment room may require cleanup several times daily to prevent asbestos materials from being tracked into the shower and clean rooms.

The Airlock

Airlocks are used to restrict air movement between contaminated areas and uncontaminated areas. They consist of two curtained doorways separated by a distance of at least three (3) feet. This spacing arrangement is necessary to allow the overlapping sheets at one end of the airlock to close before the sheets at the other end are opened.

As one passes through the initial doorway into the airlock, over-lapping plastic sheeting (weighted) seals the opening before proceeding through the second doorway, thereby preventing flow-through contamination. Figure 6-2 illustrates the proper construction of a curtained doorway.

FIGURE 6-2
Airlock Doorway Construction

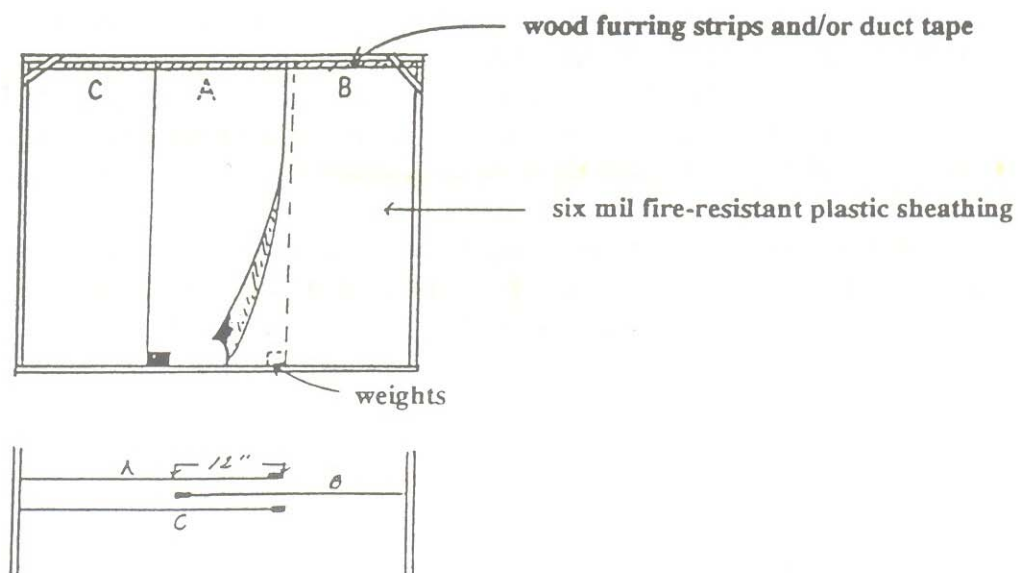

Sequential Steps For Of Personal Decontamination Systems

The following steps outline the proper sequential order of decontamination upon leaving a work area:

Step 1: Prior to entering the equipment room, rinse boots and/or foot coverings in the walk-off pan located just outside the airlock.

Step 2: Once in the equipment room, remove all protective clothing and place in labeled disposal bags. **Do not remove respiratory protection!** Proceed directly to the shower room.

Step 3: In the shower room, thoroughly wash all body parts from the neck down using adequate amounts of soap, shampoo and water. Wet hair as thoroughly as possible and avoid wetting respirator filters. Take a deep breath, hold it, complete wetting hair, face, respirator and filters. Before letting breath out, remove the respirator and hold it away from face, rinsing thoroughly.

Step 4: Dispose of wet, contaminated filters in the equipment room. Finish showering and rinse thoroughly. Exit to the clean room.

Step 5: Once in the clean room, wipe and dry the body with disposable towels. Be sure to place towels in labeled disposal bags. **Do not re-use the towels!** Change into street clothes (or into another pair of coveralls) if re-entering the work area. Remember, no food, drinks, or smoking is allowed in the clean room. Be sure to maintain the area as clean as possible.

Step 6: Sign out on the entry/exit log and exit the clean room.

Entry To The Personal Decontamination System

Adequate security measures must be taken to ensure that entry into the personal decontamination system is restricted to the following:

- The Contractor
- Employees of the Contractor
- Authorized Visitors
- Public Safety Personnel

The Waste Decontamination System

The waste decontamination system is a separate facility designed to be used as a short-term storage area for bagged asbestos waste and as a port for transferring waste to a dumpster or truck. Usually, this is a three-stage facility consisting of a washroom/cleanup room, a holding area and one airlock (see Figure 6-3).

FIGURE 6-3
WASTE DECONTAMINATION SYSTEM ENCLOSURE
LARGE ASBESTOS PROJECT
(OPTIONAL FOR SMALL ASBESTOS PROJECT)

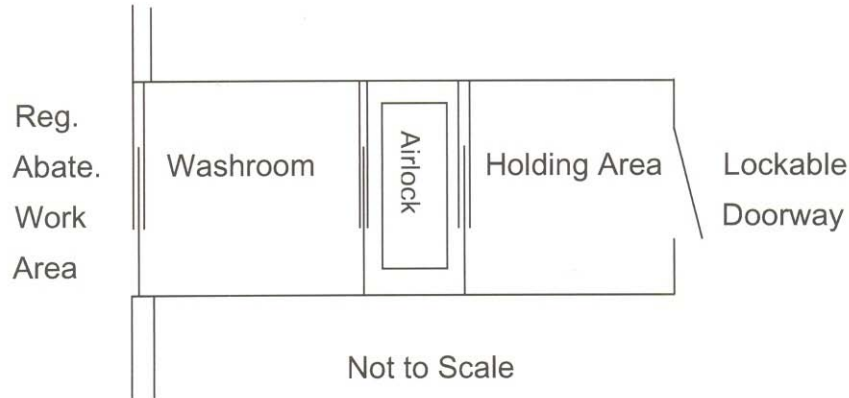

All waste and equipment exiting the work area must pass through the waste decontamination system prior to being removed from the site. External surfaces of asbestos waste bags and wrapped debris, as well as all tools and other equipment must be wet wiped and/or HEPA vacuumed in the work area before being permitted to exit the site.

Depending on the size of the project, specific waste decontamination facilities are required for asbestos abatement operations performed in New York State as detailed below.

NYS Large Projects

Large asbestos abatement projects must be equipped with a separate waste decontamination system. All equipment, tools and waste material leaving the work area must pass through this system, undergoing a decontamination process before exiting the site.

NYS Small Projects

NYS Projects (Small Project Option)

The waste decontamination system described above is *recommended* for small projects, however is not required. Where such a system is not provided, the holding area of the waste decontamination facility may branch off from the equipment decontamination room, which doubles as a waste washroom.

In small projects where only one egress from the work area exists, the shower room may be used as a waste washroom. In this instance, the clean room must not be used as a waste holding area. Waste is transferred directly through the clean room to carts and immediately removed from the enclosure.

Sequential Steps For Waste Decontamination

In general, removal of equipment and waste from the work area, through the waste decontamination system, involves two steps:

Step 1: The first team or individual (inside the work area) conducts an initial wet wiping/HEPA vacuuming of the exposed surfaces of all bags and items while still in the work area. This team or individual does not enter the waste decontamination washroom, but instead transfers only the cleaned waste bags or equipment through the airlock. At this point, a second team or individual, stationed in the washroom, continues the decontamination process.

Step 2: Once in the waste decontamination washroom, the external surfaces of all items are cleaned a second time by wet wiping. After cleaning, all excessive moisture is dried from the bags or items. Waste bags are then placed in a second 6 mil. plastic bag, with appropriate labels, wet wiped and transferred to the holding area.

Entry To The Waste Decontamination System

Adequate security measures must be taken to ensure that entry to the waste decontamination system is restricted to the following:

- The Contractor
- Employees of the Contractor
- Authorized Visitors
- Public Safety Personnel

For complete details and diagrams of decontamination facility construction, refer to NYS Code Rule 56.

FIGURE 6-4

**PERSONAL DECONTAMINATION SYSTEM ENCLOSURE
LARGE ASBESTOS PROJECT (OPTIONAL FOR SMALL ASBESTOS PROJECT)**

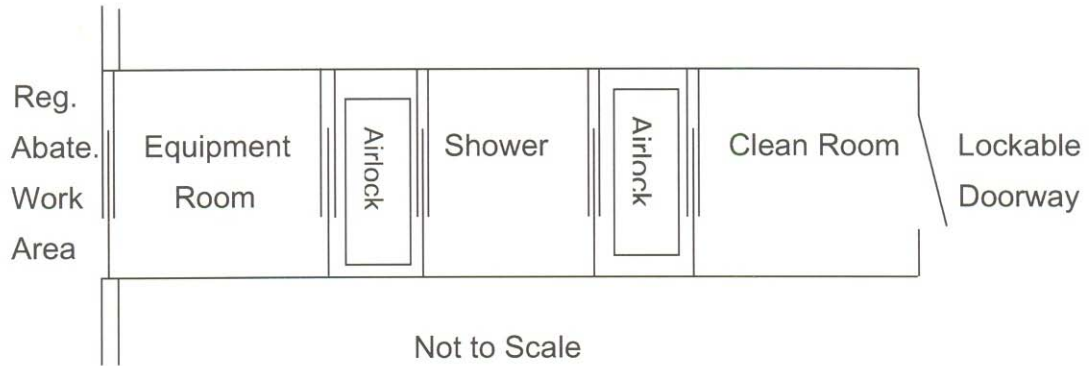

FIGURE 6-5

**PERSONAL AND WASTE DECONTAMINATION SYSTEM ENCLOSURE
FOR A SMALL ASBESTOS PROJECT**

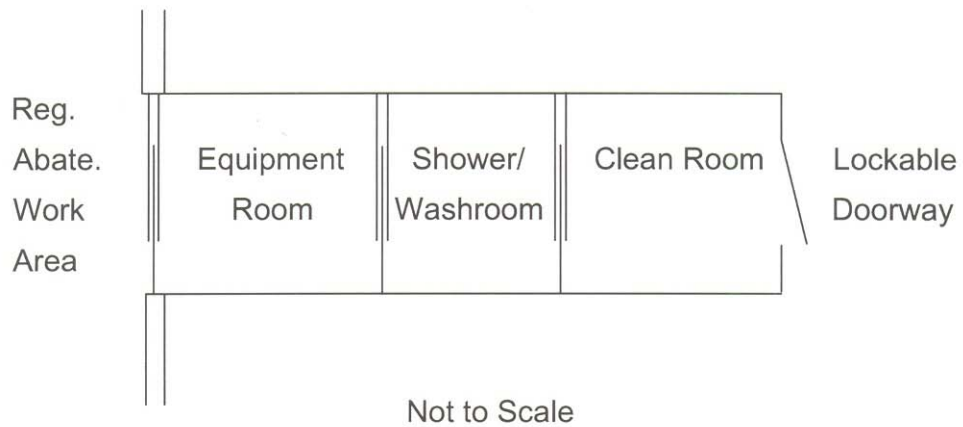

FIGURE 6-6

**WASTE DECONTAMINATION SYSTEM ENCLOSURE
LARGE ASBESTOS PROJECT
(OPTIONAL FOR SMALL ASBESTOS PROJECT)**

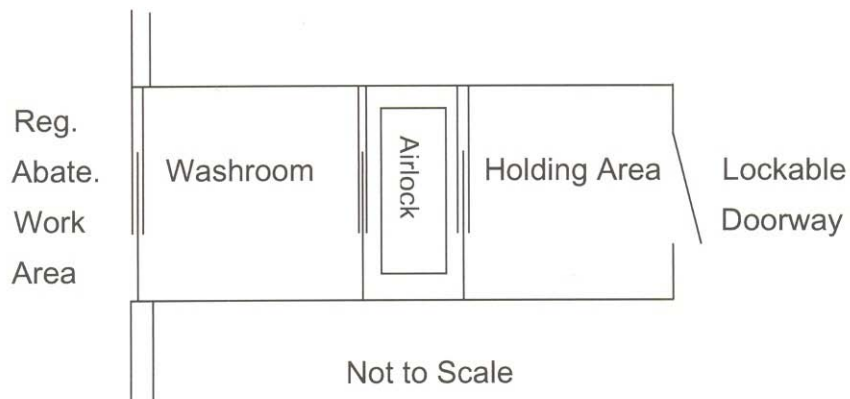
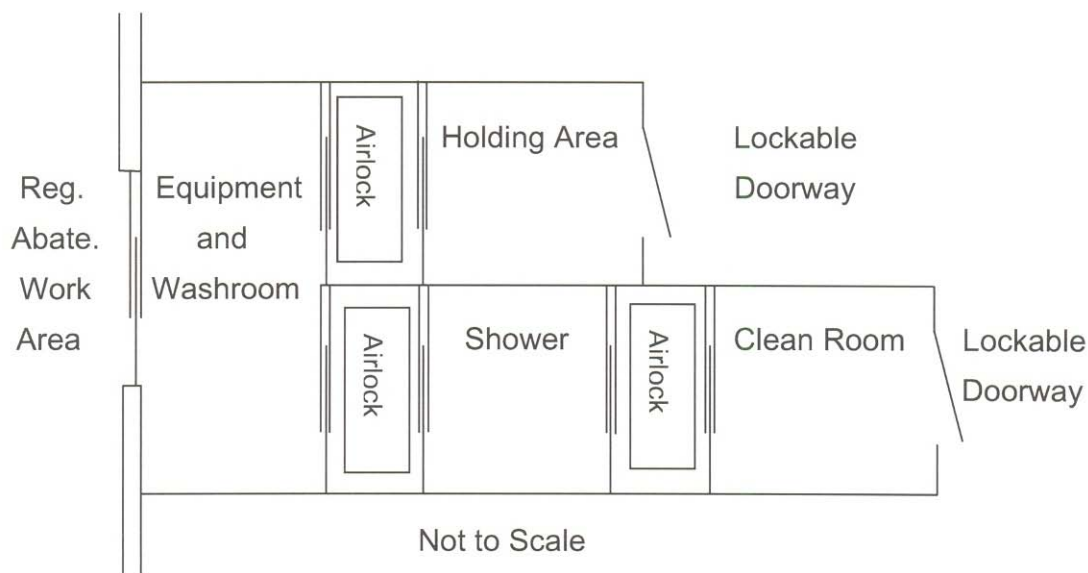

FIGURE 6-7

PARALLEL PERSONAL AND WASTE DECONTAMINATION SYSTEM ENCLOSURES

**LARGE ASBESTOS PROJECT
(OPTIONAL FOR SMALL ASBESTOS PROJECT)**



SECTION 7 PERSONAL HYGIENE

INTRODUCTION

Personal hygiene, as it relates to asbestos abatement work, is the practice of proper decontamination, personal cleanliness and good work practices. Through these efforts, the prevention of disease, both asbestos related and non-asbestos related can be accomplished. It is for these reasons that proper personal hygiene practices are a critical aspect of abatement work.

WORK AREA ENTRY AND EXIT PROCEDURES

Studies of asbestos workers over many years have conclusively demonstrated the connection between asbestos workers bringing asbestos contamination home on clothing and asbestos related disease development in otherwise non-exposed family members. To prevent this transmission of contamination to family members, as well as the worker, specific procedures have been established. Among these procedures are:

- Personal clothing, jewelry, shoes, and other articles are not to be brought into the work area.
- Protective clothing must be properly worn and properly disposed of during the decontamination process. No contaminated clothing or articles are to be brought out of the work area.
- During decontamination, the entire body must be washed thoroughly. Special emphasis should be placed on the hands and feet. Hair must be shampooed and thoroughly rinsed to remove fibers.
- Respirators must be washed and rinsed on both the outside and inside surfaces and properly sanitized.
- Never leave the work area (even momentarily) without passing through the decontamination sequence.

In addition to decontamination procedures, other work practices are important in the prevention of asbestos related disease. These practices include:

- No eating, drinking, smoking or chewing while in the work area.

- Wear protective gloves when work involves cutting or working with sharp edges. If puncture wounds or cuts occur, properly clean the wound, apply antiseptics and bandage to prevent contamination from entering the wound.
- Always report for work clean-shaven. One day's growth of beard significantly reduces the quality of respirator to face seal.
- Never remove your respirator while in the work area.
- Do not allow trash or debris to collect on the floor of the work area, the equipment room, shower room or clean room.
- Provide proper disposal facilities and ensure proper disposal practices for asbestos waste, contaminated materials and general trash.
- Do not breach the containment barriers.
- Provide adequate toilet facilities for the number of site workers.

NON-ASBESTOS DISEASE PREVENTION

Diseases other than that caused by asbestos may be contracted during the course of abatement work. Exposure to other hazardous materials may occur, including exposure to communicable diseases. Injuries may also result from improper work practices and accidents. General site safety is covered in another section of this manual, as is exposure to other hazardous materials. Therefore, this section will focus on communicable disease only.

A number of illnesses may be passed between abatement workers unless proper personal hygiene practices are followed. To prevent or minimize the possibility of the spread of communicable disease, the following procedures must be followed:

- Each employee shall be assigned a personal respirator. Workers must never wear another person's respirator without proper cleaning and sanitizing.
- Do not work if sick or taking medications which may interfere with work performance or safety.
- Seek proper treatment of any cuts or wounds which may allow entry or transmission of disease.
- Bathe regularly.
- During decontamination wash hands, feet and hair thoroughly.

- Report any condition, which may interfere with work performance or result in the potential transmission of disease to other employees.
- Don't clean protective clothing each time you enter the work area.
- Do not use other employee's protective equipment such as hard hats, eye protection, shoes, etc.

In addition, a good practice is to frequently sanitize the floors of the shower room and clean room to prevent the transmission of fungal infections such as athlete's foot.

FIGURE 7-1

Work Area Entry and Exit Procedures

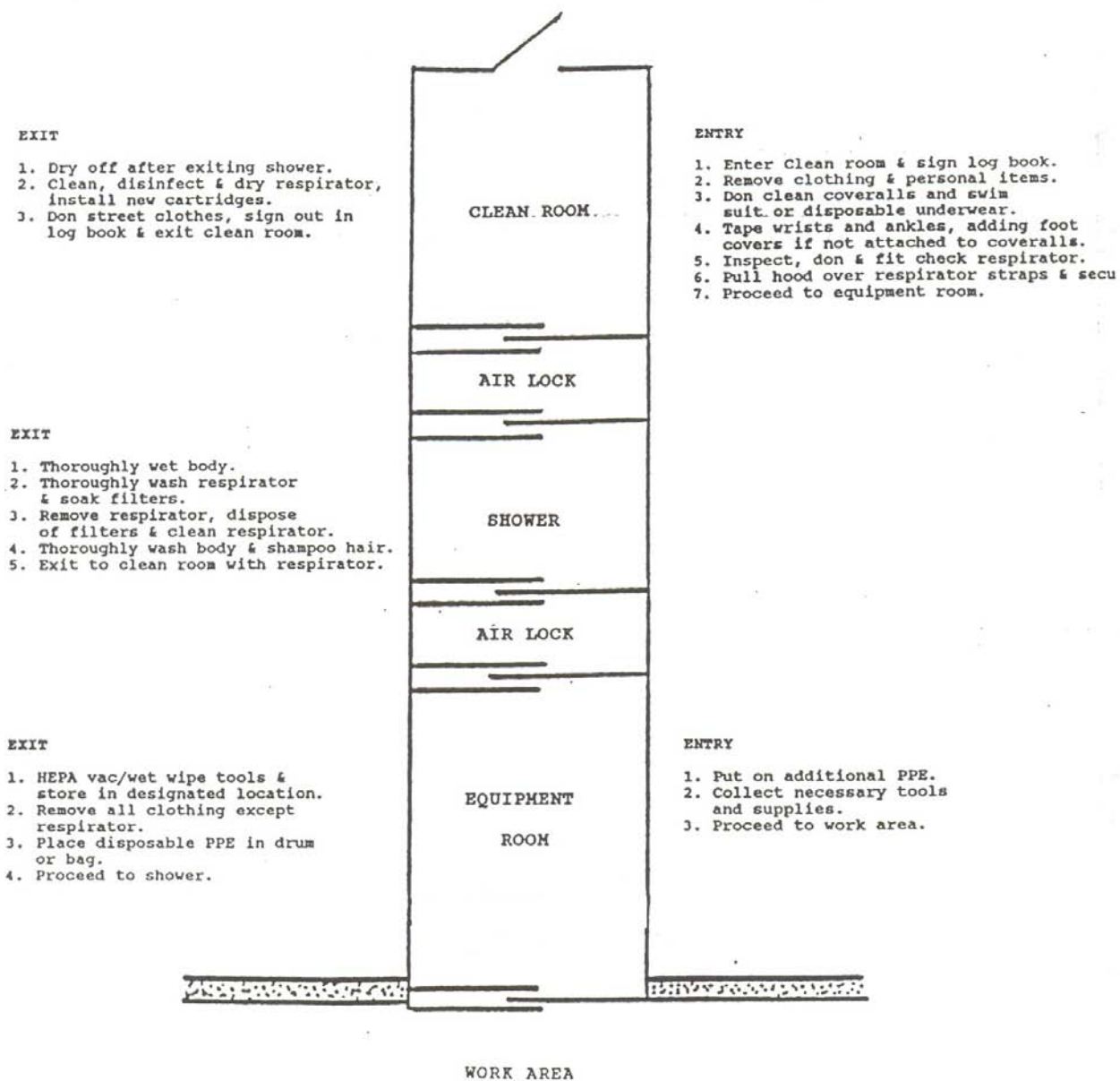

SECTION 8 WORK AREA PREPARATION

INTRODUCTION

A key element to ensuring a safe and successful project, regardless of the size, depends heavily upon the quality and thoroughness of all work area preparation activities. Meticulous work area preparation prior to an abatement action serves to:

- Ensure the health and safety of all building occupants before, during and after abatement activities.
- Protect the abatement worker from additional safety hazards that may be encountered during abatement operations (see section 11; General Safety Considerations).
- Protect the Owner's property from damage resulting from the use of water or other abatement techniques.
- Greatly reduce both effort and time required for maintenance during the abatement activities and during post-abatement clean up.

STEP 1: HOLD A PRE-CONSTRUCTION MEETING

Conduct a pre-construction meeting with all parties associated with the project. The meeting should outline and summarize the proposed scope of work, as well as the responsibilities of each participant. It should be followed by a comprehensive walk-through of the planned work area with the Project Designer/Architect/Engineer, Owner or Owner Representative. This walk-through should assist the Contractor in the identification of any particular project concerns or needs as well as confirming the feasibility of work area specification requirements. The following check list provides some of the essential items that should be addressed:

- The work area can be adequately secured from the general public and those not directly associated with the project.
- Confirm that all project notification requirements have been met.
- The location/amount/condition of ACM to be abated.
- Availability of sufficient sources of water and wastewater drainage sites.
- Access to remote sources of electric.

- Adequate storage space for abatement equipment and supplies.
- Work area climate conditions, limitations, etc.
- Review potential safety hazards associated with the planned work area.
- Work area ventilation concerns, including confined space issues and the building's ventilation requirements.
- Availability of toilet facilities for workers.
- Availability and clear identification of emergency exits or escape routes.

STEP 2: VACATE WORK AREA

The work area should be vacated by the building occupants prior to work area preparation activities and until satisfactory Clearance Air Monitoring results have been achieved.

STEP 3: POST CAUTION/WARNING SIGNS

Proper caution sign should be posted at **ALL** entrances or approaches to a specified work area. All warning signs should be posted in a manner, which permits a person to easily read the sign and take the necessary protective measures to avoid exposure. An example of a sign is given in Figure 7-2 below.

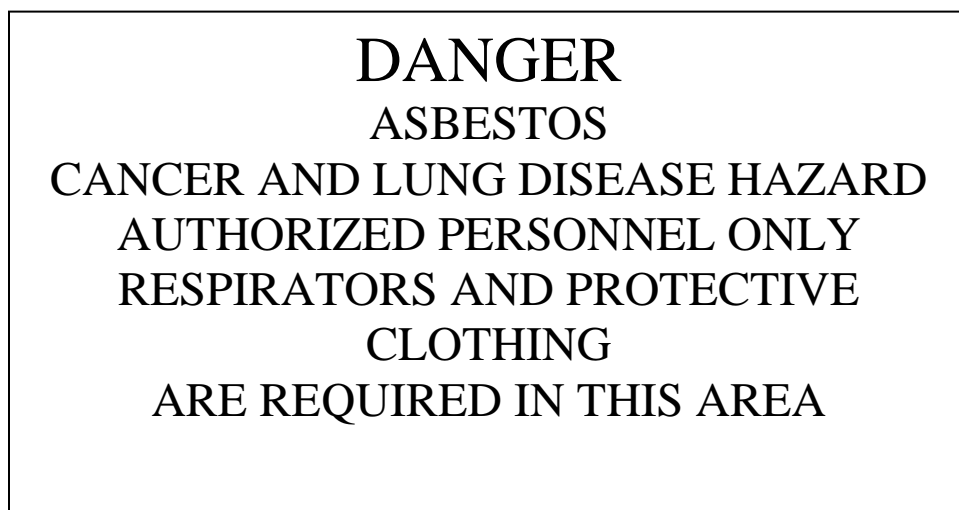

STEP 4: PERSONAL and WASTE DECONTAMINATION ENCLOSURE SYSTEM INSTALLATION

Prior to any pre-abatement activities and in particular, prior to disturbing any asbestos-containing material, an appropriate personal decontamination enclosure system shall be constructed or installed. Depending on the scope of the abatement activities to be performed, this facility may be attached to, or adjacent to but remote from the work area.

STEP 5: LOCK-OUT ALL WORK AREA ELECTRIC

To avoid electrical hazards (fires, electrocution, etc.) and possible bodily injury, all electric power to the work area(s) must be shut down and locked out/tagged out prior to any abatement activities, according to OSHA's Lockout/Tagout Standard. The following actions should be taken:

- Identify and de-energize electric circuits in the work area.
- After the system has been shut down, lock the breaker box, or individual breaker and attach a warning label on it.
- Make provisions for supplying the work area with electricity from outside the work area. All power supplied to the work area must first pass through a ground fault circuit interrupter (GFCI).
- If the normal electrical supply to the work area cannot be disconnected, all energized parts must be insulated to guard against accidental contact.

STEP 6: HEATING, VENTILATION, AND AIR CONDITIONING ISOLATION

The heating, ventilation, and air conditioning (HVAC) system supplying the work area should be shut down and/or isolated to prevent contamination and the dispersal of asbestos dusts to other areas of the building or structure. This may be accomplished by using any or all of the following methods:

A. General System Shut Down and Isolation

To avoid inadvertent activation of the HVAC system during abatement operations, the system's control panel should be tagged (label advising personnel not to activate) and locked out with appropriate devices.

All vents, ducts, grills, plenums, HVAC system seams (those that pass through the work area) and any other system penetrations should be covered with at least two (2) layers of at least six mil. fire-retardant plastic sheeting and sealed with duct tape.

All HVAC system filters present within the work area which are contaminated with asbestos or are suspected of being contaminated should be handled and disposed of as asbestos containing waste.

The building physical plant engineering staff should be well informed of any HVAC system modifications necessary.

B. Local Isolation

Local HVAC system isolation refers to the isolation of specific sections of an HVAC system (rather than the entire system) which enters/exits the proposed work area. Similar techniques and methods of system isolation and lock out, as previously described under general system isolation, should be employed. Temporary HVAC systems may be constructed/fabricated to by-pass sections within the work area if the situation requires it. This does not, however, release the abatement contractor from isolating the non-functional sections.

C. Positive Pressurization

Positive pressurization refers to the creation of a pressure gradient within the HVAC system that is positive with respect to the outside of the duct. With the establishment of an adequate pressure gradient, the prevention of contaminated air entering the HVAC system is enhanced.

All HVAC duct and plenum outlets, inlets and exhaust dampers should be sealed with sheathing and/or caulking, covered with at least two (2) layers of six mil. fire-retardant plastic sheeting and taped airtight. This includes duct and plenum joints.

A positive pressure within the HVAC system is produced by mixing and balancing system damper positions and by shutting down the return fan(s). All supply fans should be locked in the "on" position.

The following conditions/limitations should be considered prior to using positive pressurization techniques:

1. Project Phasing
2. Climate Conditions
3. HVAC System Load Conditions/Limitations
4. HVAC System Aerodynamics
5. Potential HVAC System Damage

The presence of adequate HVAC positive pressure should be demonstrated and confirmed daily during the course of an abatement project. (In New York State, NYS Industrial Code Rule 56 requires the use of a manometer).

STEP 7: PRE-CLEAN AND REMOVE MOVABLE OBJECTS/FIXTURES

Wearing half-face air purifying respirators equipped with HEPA cartridges and disposable coveralls, workers should pre-clean all movable objects prior to removing them from the work area to uncontaminated areas. Pre-cleaning methods should include the use of HEPA filtered vacuum equipment and/or wet cleaning methods.

Items such as upholstered furniture and drapes should be HEPA vacuumed twice prior to their removal from the work area. If carpets are to be reused, they should be HEPA vacuumed twice and steam cleaned before removing them from the work area. Carpets left inside the work area should be pre-cleaned and covered with half-inch thick sheathing prior to required plasticizing.

Light fixtures may have to be removed or detached and suspended temporarily to access asbestos-containing materials. Regardless of whether they remain within the work area or are removed, they should be pre-cleaned. If they are to remain within the work area, they must be wrapped with at least two layers of six mil. fire-retardant plastic and sealed with tape after cleaning.

STEP 8: PRE-CLEAN AND PLASTICIZE FIXED OBJECTS

After pre-cleaning all movable objects and removing them from the work area, those objects considered fixed or stationary should be pre-cleaned using HEPA vacuuming and/or wet cleaning methods. Once cleaned, these items must be sealed with at least two layers of six mil. fire-retardant plastic sheeting and taped.

Items such as water fountains should be disconnected, sealed with two layers of plastic sheeting, and labeled non-operational. This will help discourage most individuals from disturbing the plastic covering with the intention of getting a drink.

All electrical outlets, service panels, exposed wire ends and switch plates within the work area should be shut down, locked out and sealed with two layers of six mil. fire-retardant plastic sheeting and taped.

STEP 9: GENERAL WORK AREA PRE-CLEANING

The entire work area should be pre-cleaned while exercising caution not to disturb any in-place asbestos-containing materials. The use of brooms (dry sweeping), vacuums not equipped with HEPA filtration units or other methods that may be prone to raising dust are prohibited.

STEP 10: INSTALLATION OF ISOLATION BARRIERS

Once the proposed work area has been pre-cleaned, isolation barriers that seal off all openings, seams and penetrations to the work area must be fabricated and installed.

A. Windows, Doors, etc.

The edges of all windows, regardless of whether they are functional or non-functional, within the work area should be sealed with duct tape having a width of approximately 3 inches. After installing this initial tape seal, they must be covered with at least two layers of six mil. fire-retardant plastic sheeting and sealed with tape.

B. Wall/Partition Construction

All other openings that are thirty-two (32) square feet or less should be covered and sealed in a similar manner as mentioned above. However, if the opening is greater than thirty-two (32) square feet (except where one dimension is one foot or less), a solid wall consisting of wood or metal framing covered with at least three-eighths inch thick sheathing material must be constructed over the opening. The edges of the wall or partition must be caulked at the floor/base, ceiling/top and all other sides to form an airtight seal.

If more than one partition is constructed, each section must be caulked prior to plasticizing. Once constructed, the side facing the work area must be plasticized with double layer of at least six mil. fire-retardant plastic sheeting with staggered joints and taped edges.

C. Plasticizing/Sealing: Work Area Surfaces

All floor, wall and ceiling surfaces, except where abatement of ACM, PACM or asbestos material shall be performed on those specific surfaces, shall be covered with two (2) layers of, at a minimum, six (6) ml fire-retardant plastic sheeting. The floor shall be plasticized first, and its plastic shall extend up the walls a distance of at least twelve (12) inches on all sides. The walls shall then be plasticized by applying plastic sheeting from the ceiling to the floor, overlapping the floor sheeting by at least twelve (12) inches. Next, the ceiling shall be plasticized overlapping the walls by at least twelve (12) inches, to form a secure airtight seam. This process shall be repeated for the second layer of plastic sheeting for the floor, walls, and ceiling. All seams within a layer shall be separated by a distance of at least six (6) feet and sealed air tight with duct tape. All seams between layers shall be staggered by at least two (2) feet.

It may be advantageous to install additional layers of plastic sheeting or use reinforced six mil. plastic sheeting in those areas where heavy traffic is expected. When covering stairs, ramps, or other potentially slippery spots with plastic sheeting, care must be taken to ensure that proper traction is provided for foot traffic.

STEP 11: OTHER WORK AREA PREPARATION CONSIDERATIONS

A. Suspended Ceilings

Suspended ceiling tiles and T-grid components that have been contaminated with asbestos-containing materials should not be disturbed or removed until the work area has been fully plasticized. In addition, personal and equipment decontamination facilities must be in place and functional.

B. Emergency Work Area Exits

Once the work area has been prepared, it is important to establish and clearly identify emergency exit locations.

All exits and emergency exits must be clearly identified and all workers informed of their locations prior to abatement activities. Many methods of marking such areas are available and may include:

- The use of arrows constructed with duct tape or reflective tape and secured along barrier wall surfaces, leading to all exits. Due to the raised edges of the tape, an individual can feel his/her way to an exit if the area is smoke filled or darkened.
- Color-coded tape along the floor edges leading to exits. Precautions must be taken to avoid damaging this tape during abatement activities.
- Self-illuminating exit signs and/or arrows may also be used.

C. Boiler Area

When feasible (mandated by NYS Industrial Code Rule 56), boilers should be shut down for the duration of the project. The burner and boiler accesses and breechings must be sealed with at least two layers of fire-retardant plastic sheeting and taped. These areas must remain sealed until satisfactory clearance air monitoring of the area has been achieved.

D. Elevator Isolation

If elevators are present in the work area, NYS Code Rule 56 requires that they be shut down and sealed as described in STEP 10-B. However, since this is rarely feasible, there are acceptable methods of isolating an elevator, as well as the elevator shaft ports, from the immediate work area without interrupting service to other parts of the building.

Operational Elevators

The following isolation techniques must be employed when an elevator is to remain functional within an asbestos abatement project work area:

- The elevator door frames must be enclosed within a wooden structure consisting of 3/8" thick plywood with 2" x 4" framing, sixteen inches center-to-center, and caulked at all seams.
- The structure must then be covered with two seamless layers of at least six mil. fire-retardant plastic sheeting and sealed airtight with a quality duct tape.

- A final larger layer of at least six mil. fire-retardant plastic sheeting must be secured airtight around its perimeter, but with a little slack. This final layer performs as a large diaphragm to indicate leakage or any air movement caused by the elevator operation.

Elevator Shaft Ports

Occasionally, elevator shaft ports functioning to equalize pressure within the elevator shaft may be present within the proposed work area. Such ports must be vented to the outside or to non-work areas.

E. Toilet Facilities

Often overlooked during work area preparation activities, adequate toilet facilities must be readily accessible to all workers during an abatement operation. If such facilities are lacking, an adequate number of portable units must be provided and located adjacent to the work area.

(Refer to OSHA Sanitation Standards).

MATERIALS AND EQUIPMENT LIST

Work Area Preparation

Fire-Retardant Plastic Sheeting

- Types:
- 6 ml. thickness 10' x 100' clear
 - 6 ml. thickness 20' x 100' clear
 - 20' ml. thick 20' x 100' clear / reinforced
- Uses:
- Isolation barrier fabrication
 - Cover fixed objects, floors, walls and ceilings
 - Cover work area openings and penetrations
 - Decontamination unit construction

Duct Tape

- Types:
- 2" x 60 yards - quality grade / color optional
 - 3" x 60 yards – quality grade / color optional
- Uses:
- Sealing edges and seams of plastic sheeting
 - Sealing small openings
 - Supporting plastic sheeting

Adhesive Spray

- Types:
- Industrial grade, water resistant
- Uses:
- Securing seams of plastic sheeting
 - Supporting plastic sheeting

Caulk

- Types:
- Industrial grade, heat resistant
- Uses:
- Sealing seams of wall partitions/critical barriers prior to plasticizing
 - Sealing various small openings and penetrations
 - Ensure airtight/watertight joints whenever sheathing materials are used

Expanding Foam Sealant

- Types:
- Polyurethane expanding foam
- Uses:
- Fill small gaps, crevices, penetrations that are difficult to adequately seal with plastic sheeting alone. Note: Most expanding foams must be covered with a thermal barrier and should not be exposed to temperatures above 250° F.

Furring Strips

- Types: - Strips of wood – cut into blocks
Uses: - Support vertical/horizontal plastic sheeting

Nails / Fasteners

- Types: - Various sizes of common nails (with a head)
Uses: - Attach furring strips
- Construction framing/partition fabrication

Staples / Staple Gun / Hammer

- Types: - Industrial grade – manual
Uses: - Attaching plastic sheeting to wooden framing

Utility Knives

- Types: - Replaceable / retractable blades
Uses: - Cutting plastic sheeting / duct tape

High Efficiency Particulate Air Filter (HEPA) / HEPA Equipped Vacuum Cleaners

- Types: - Size and model to suit project needs
Uses: - All pre-cleaning of horizontal & vertical surfaces
- Fixed and moveable object decontamination
- All final cleaning of horizontal & vertical surfaces

Mops, Buckets, Cleaning Cloths

- Types: - Mops with disposable heads
Uses: - Wet cleaning activities

Warning Signs / Barrier Tape

- Types: - Plastic / metal / disposable with appropriate wording
Uses: - Establishing work areas / work zones
- Post all entrances to work areas and decontamination facilities

- Ladders / Scaffolds
- Various Carpentry Tools
- Sheathing Materials (3/8" plywood)
- HEPA Equipped Negative Ventilation Units & Pre-Filters
- Water Filtration Units (at least 5.0 µm filtration)
- Pressure Manometer / Pressure Recording Instrumentation
- Smoke Tubes

SECTION 9 ENGINEERING CONTROL TECHNIQUES

INTRODUCTION

Engineering controls are often defined as methods of controlling concentrations of contaminants by modifying the source or reducing the quantity of contaminants that are released into the work environment. The preparation phase of an asbestos abatement project is directed towards the isolation of the work area and its components from all other areas within a building. As an engineering control measure, its primary function is to contain the airborne asbestos fibers which will be generated during asbestos material removal, repair, encapsulation or enclosure activities. In addition to contaminant barriers, decontamination facilities are designed and constructed to prevent the spread of asbestos fiber contamination outside the work area, by directing all abatement personnel, clothing and equipment through a carefully planned sequence of decontamination.

Additional engineering controls include:

- Negative Air Pressure Ventilation/Filtration (HEPA) Equipment.
- HEPA Equipped Vacuum Cleaners.
- Wet Removal Techniques.
- Encapsulation Techniques.
- Enclosure Techniques.
- Glove Bag Use.
- Good Housekeeping.

NEGATIVE AIR PRESSURE FILTRATION SYSTEMS*

Negative pressure filtration systems serve two primary goals:

1. **Air Filtration:** Changing the contaminated air within the containment is required at least four (4) times every hour, removing particles down to 0.3 microns with 99.97% efficiency.
2. **Negative Pressure:** Establishing a pressure gradient inside the work area which is lower (negative) in relationship to the environment outside the containment barriers.

* Reproduced, with modifications, from U.S. EPA report Guidance for Controlling Asbestos-Containing Materials in Buildings. EPA 560/5-85-024. June 1985.

In addition, negative air pressure systems:

- Protect against large-scale release of fibers to surrounding areas in the event of a breach of the containment barriers.
- Reduce the concentration of airborne fibers in the work area.
- Increase worker comfort and productivity.
- Improve efficiency during final cleanup activities.

Materials and Equipment

Negative air pressure units are known by several different trade and generic names, including Micro-Trap™, Red Baron™, Hog™, micro-filter, HEPA units and negative pressure systems.

Mechanical and Structural Concerns

Since these units are usually subjected to rough handling and transportation, the cabinet should be ruggedly constructed and made of durable materials to withstand potential damage.

- The cabinet should be less than 30 inches, allowing it to pass through standard-sized doorways
- The cabinet must be properly sealed to prevent asbestos-containing dust from being emitted during use, transport or maintenance
- There should be access to all air filters from the intake end, and the filters must be easy to replace
- The unit should be mounted on casters or wheels to facilitate easy movement
- It should be accessible for easy cleaning

Mechanical Specifications

A. Fans

The unit should have an air handling capacity of 1,000 to 2,000 cubic feet per minute (ft³/min) under “clean” filter conditions.

It is important to take into consideration the age and condition of the units you are planning to use. The manufacturer’s ratings, appearing on each unit, refers to the specifications for a new, unused machine. These specifications are subject to change with use, age and degree of filter loading. A safe rule of thumb is to use 65 to 75% of the actual specifications to calculate volumes.

Other elements that will affect the overall performance of a negative air pressure machine include: 1) the length of attached exhaust hoses; 2) the width of exhaust hoses; and 3) any added transitions, bends, reductions or couplings to an exhaust hose.

B. Filters

Pre-filters, which protect the final filter by removing the larger particles, are recommended to prolong the operating life of the HEPA filter. The first-stage pre-filter should be a low efficiency type for the collection of particles 10 microns and larger. The second-stage filter, also referred to as the intermediate pre-filter, should have a medium efficiency rating, effective for particles down to 5 microns.

The final filter must be a HEPA, a high efficiency particulate air filter capable of trapping and retaining 99.97% of all mono-dispersed particles of 0.3 microns in diameter or larger .

C. Instrumentation

Each unit should be equipped with a magnehelic gauge or manometer to measure the pressure drop across the filters and indicate when filters have become loaded. To ensure the proper functioning of the negative air units, the filters must be changed when the instrumentation indicates excessive static pressure increases.

Electrical Specifications

A. General

The electrical system should have a remote disconnect (i.e. circuit breaker) and never be hard-wired to a power source. The fan motor should be totally enclosed, fan-cooled, and be of the non-overloading type. The unit must use a standard 120-V, single phase, 60-cycle service. All electrical components must be UL (Underwriter's Laboratories) Listed and meet ANSI AIHA Z9 specifications.

B. Fans

The motor, fan, fan housing and cabinet should be grounded. The unit should have an electrical (or mechanical) lockout to prevent the fan from operating without a HEPA filter installed.

C. Instrumentation

An automatic shutdown system that would stop the fan in the event of a major rupture in the HEPA filter or blocked air discharge is highly recommended. Optional warning lights are recommended to indicate normal operation, too high of a pressure drop across filters resulting from overloading, and too low of a pressure drop, resulting from a rupture in the HEPA filter or an obstructed discharge.

Setup and Use of a Negative Pressure System

A. Approximate Ventilation Requirements for a Work Area

The volume (in ft³) of the work area is determined by multiplying the floor area by the ceiling height. The total air flow requirement (in ft³/min) for the work area is determined by dividing this volume by the minimum required air change rate of one air change every 15 minutes.

$$\text{Total ft}^3/\text{min} = \text{Volume of Work Area (in ft}^3\text{)} / 15 \text{ min.}$$

The number of units needed for the application is determined by dividing the total ft³/min by the rated capacity of the exhaust unit (with all filters installed).

$$\text{Number of Units Needed} = [(\text{Total ft}^3 / \text{min}) / 75\%] / \text{Capacity of Unit (in ft}^3\text{)}$$

New York State asbestos regulations require that at least one (1) additional unit, having a rated capacity at least to that of the primary (or largest) unit, be installed as a backup. It is to be used in the event of a primary unit failure as well as during primary unit filter changes. In addition, the negative air equipment shall be on GFCI protected circuits separate from the remainder of the regulated abatement work area temporary power circuits.

B. Location of Exhaust Units

The exhaust unit(s) should be located so that make-up air enters the work area primarily through the decontamination facilities and traverses the work area as much as possible.

A temporary power supply (115V AC) must be available to satisfy the requirements of the total of all exhaust units (including back-up units). All power supplied to the work area, including HEPA exhaust units, should first pass through a ground-fault circuit interrupter.

New York State requires that air monitoring and daily inspections be conducted to ensure that the exhaust ducts are properly installed so as not to release asbestos fibers into uncontaminated areas. In addition, they mandate that "at no time shall the negative pressure units exhaust within 15 feet of a receptor or adversely affect the air intake of the building/structure or other buildings/structures."

If exhaust air cannot be vented to the outside of the building or if cold temperatures necessitate measures to conserve heat and minimize cold air infiltration, filtered air may be vented into an adjacent, unoccupied area. However, in New York State, the Contractor would have to obtain a Site Specific Variance to permit use of this option.

Auxiliary makeup inlets, if necessary, should be located as far as possible from the exhaust unit(s), off the floor (preferably near the ceiling), and away from barriers that separate the work areas from occupied clean areas.

Because the pressure differential (and ultimately the effectiveness of the system) is affected by the adequacy of makeup air, the number of auxiliary air inlets should be minimized.

Figure 9-1
Examples of Negative Pressure Systems

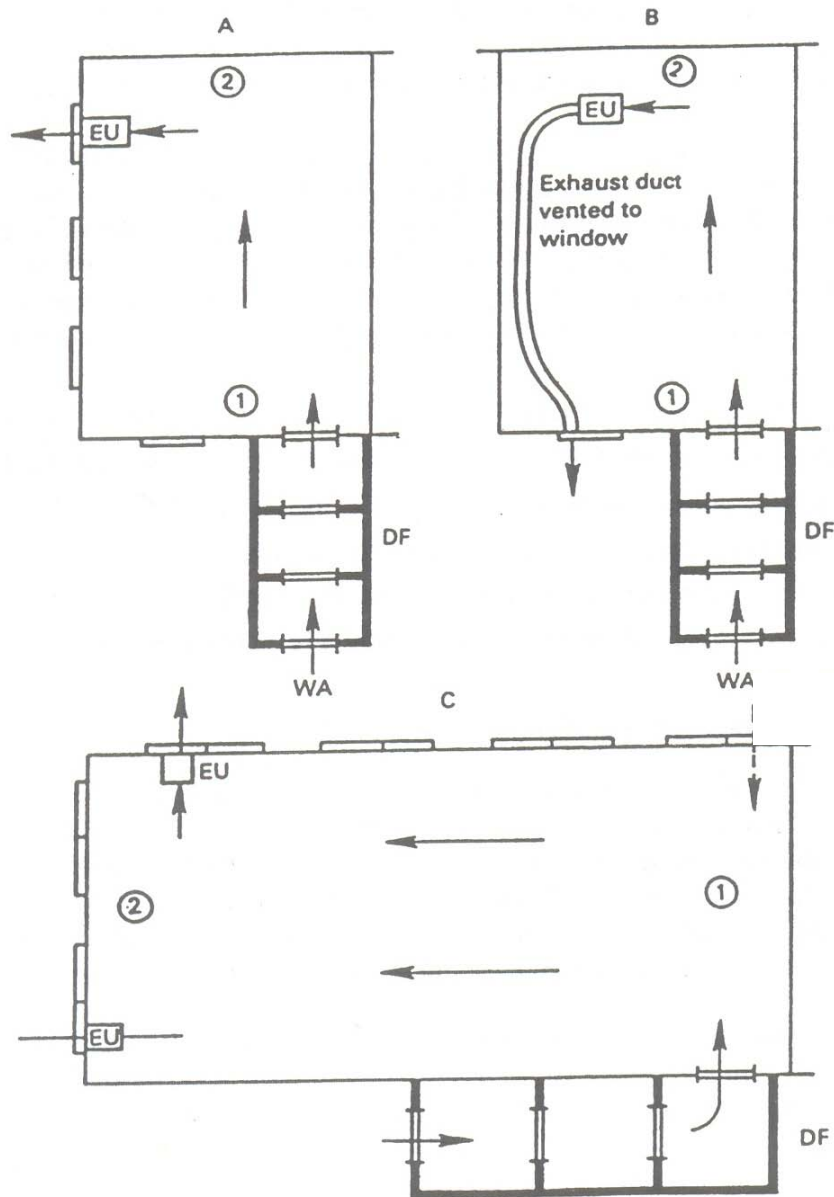

DF- Decontamination Facility; EU – Exhaust Unit; WA – Worker Access; A – Single room work area with multiple windows; B – Single room work area with one window; C – Large single room work area with windows. Arrows denote direction of air flow. Circled numbers indicate progression of removal sequence.

NOTE: Use of Auxiliary make up air is not allowed under Part 56 except through the use of an approved site-specific variance.

C. Testing the System

Once the decontamination system is set up and functional, and the isolation barriers and critical barriers have been installed, the exhaust unit(s) (with at least one backup) must be installed and operating. If more than one unit is required to obtain the necessary negative pressure, then they should be started one at a time, allowing adequate time for each motor in turn to come up to normal operating speed. Observe the barriers and the plastic sheeting. The plastic curtains (weighed at the base) of the decontamination facility(s) should move slightly inward toward the work area.

The negative pressure system should be tested before any asbestos-containing material is wetted or removed. The use of smoke tubes is an easy and inexpensive way to visually check the ventilation system performance and direction of air flow through openings in the barrier, and is required in New York State. In addition, a more accurate test (a manometer) is also required to be used to measure the static pressure differential across the barriers. The measuring device must be sensitive enough to detect a relatively low-pressure drop. A Magnehelic gauge with a scale of 0 to 0.25 or 0.50 inch of H₂O and 0.005 or 0.01 inch graduations is generally adequate.

Several “new” and fairly sophisticated real-time instruments are available to measure and document negative pressures within a work area throughout the course of an abatement project. These instruments are permanently installed in the plastic barrier, and either data log current pressure measurements or record them directly on flow sheets. An audible and/or visible alarm may be used to alert the project manager of a significant drop in pressure. A pressure drop of - 0.02 inches of water should be maintained throughout a project.

D. Use of System During Removal Operations

New York State regulations require a pre-abatement waiting period upon completion of the enclosure system. Prior to beginning actual abatement activities, a waiting period of at least 4 hours must be allowed to insure that all barriers and plastic sheeting will remain intact and secured to the walls and fixtures. In addition to this waiting period, NYS mandates daily inspection and testing of all barriers and enclosure systems (including decontamination facilities) for system integrity and adequate negative pressure.

Code Rule 56 requires that negative pressure must be maintained in an enclosure system throughout the abatement operation until satisfactory clearance air has been achieved.

If an electric power failure occurs, all removal must stop immediately and should not resume until power has been restored and exhaust units are properly operating.

E. Filter Replacement

All filters must be accessible from the work area or “contaminated” side of the barrier. The average operating life of a HEPA filter depends on the level of particulate contamination in the environment in which it is used.

When the pressure drops across the filters (as determined by the Magnehelic gauge or manometer on the unit) exceeds 1.0 inch of H₂O, the prefilter should be replaced first. Any dust dislodged from the prefilter during removal will be collected on the intermediate filter. The used prefilter must be placed inside a six mil. plastic bag, sealed and labeled, and disposed of as asbestos waste. A new prefilter is then placed on the intake grill. The negative air machine should remain on during filter replacement.

If the pressure drop still exceeds 1.0 inch of H₂O after the prefilter has been changed, the intermediate filter is replaced. With the unit operating, the prefilter should be removed, the intake grill or filter access panel opened, and the intermediate filter removed. Any dust dislodged from the intermediate filter during removal will be collected on the HEPA filter. The used intermediate filter must be placed in a six mil. plastic bag (appropriately labeled) and disposed of as asbestos waste. A new replacement filter is then installed and the grill or access panel closed. Finally, the prefilter on the intake grill should be replaced.

When replacement of the prefilter and/or intermediate filter does not restore the pressure drop across the filters to its original clean resistance reading (usually within 75% or greater), the HEPA filter must be replaced. This holds true if the HEPA filter becomes damaged (torn, crushed, absorbs too much water, etc.). Replacement of the HEPA filter must never be done during abatement activities. To replace the HEPA filter, the unit must be shut “off” and disconnected from the power source. Ideally the unit (after a backup unit has been activated) should be moved to the equipment section of the decontamination unit where it can be thoroughly wet-wiped and HEPA vacuumed prior to disassembly.

First, the prefilter is removed, then the intake grill or access panel is opened to remove the intermediate filter and gain access to the HEPA filter. The HEPA filter is then removed from the unit’s housing and replaced with a “new” one (same dimensions and/or item number). Used HEPA filters must be placed in a seal-able six mil. plastic bag (appropriately labeled) and disposed of as asbestos waste.

While the unit is disassembled, it is a good time to check all filter gaskets and the unit’s housing for signs of damage, gaps or cracks. Worn gaskets should be replaced as needed. Whenever the HEPA is replaced, the prefilter and intermediate filter should also be replaced.

Prefilters may be replaced two to four times a day when accumulations of particulate matter become visible. Intermediate filters must be replaced once every day or so, and the HEPA filter may be replaced at the beginning of each new project. On the whole, conditions inside the work area will dictate the frequency of filter changes.

F. Dismantling the System

As gross removal nears completion, filters should be checked for loading and replaced if necessary. If a prefilter is being used on the outside of the exhaust unit, it should be removed prior to final cleanup. When the negative pressure system is shut down at the end of the project, the filters should be left in the exhaust units and the openings sealed with plastic and tape.

Note: Filters in the exhaust system should not be replaced after final cleanup is complete in order to avoid any risk of re-contaminating the area.

Useful Tips on Negative Pressure Systems:

- Changing out the ½" prefilter frequently (every 20-30 minutes) during heavy removal will prolong the life of the much more expensive HEPA filter.
- The use of supplied air respirators will increase the air pressure in the work area. This may result in the need for additional negative air units.
- Most negative air machines will demand 18 amps during start-up and 15 amps during normal operation.
- Negative air machines usually pull less volume than the rating assigned by the manufacturer due to wear, and as filter loading occurs.
- Negative air systems are most effective in reducing fiber counts when the units are located within the enclosure at the farthest point from the makeup air (eg, the decon systems).

HEPA EQUIPPED VACUUM CLEANERS

Both Federal and State regulations prohibit the use, during abatement activated, of any methods which are likely to raise asbestos-containing dust, such as dry sweeping or vacuuming with equipment not equipped with HEPA filters, such as standard household vacuums or wet/dry shop vacs.

In the past several years, the abatement industry has witnessed a growth in vacuum technology that has produced large, sophisticated truck-mounted systems (REACH™ Guzzler Manufacturing, Inc.) to very small systems that are easily carried on a worker's back.

Ultra High Efficiency Particulate Air Filtration

The latest newcomer to the vacuum market is the Ultra High Particulate Air filter with a reported efficiency rating as high as 99.9995 percent at 0.12 microns size range.

Adaptability

Some abatement projects may require intrinsically safe units capable of being powered by compressed air or units which incorporate elaborate electrical systems to protect computer and clean rooms from excessive electromechanical interference (EMI).

Several vacuum manufacturers have incorporated built-in pressure manometers with adjustable valves for maintaining negative pressure in glove bag and tent applications. Many manufacturers provide special tools and attachments to help expand the overall versatility of a vacuum.

WET REMOVAL TECHNIQUES

The EPA, OSHA and many State regulations mandate the use of wet removal techniques. This involves wetting the asbestos containing material thoroughly before removal begins, keeping it adequately wet as it is removed and while it is being bagged. The term “adequately wet,” as defined by the Asbestos NESHAPS (40 CFR, part 61, Subpart M, 1990), means to sufficiently mix or penetrate the material with liquid to prevent the release of particulates. If visible emissions are observed coming from ACM, then the material *has not* been adequately wetted.

New York State regulations do not permit the dry removal or disturbance of any asbestos materials. During wet removal, abatement workers must ensure that a sufficient amount of time is allowed for liquid penetration to occur prior to beginning removal efforts. It is not acceptable to merely wet the outer surface and assume that this constitutes appropriate saturation. Those asbestos materials that are non-hygroscopic (absorb water poorly or not at all) must be thoroughly wetted on a continual basis, and may require the use of special wetting agents.

Under special situations, the use of wet removal techniques may be inappropriate and actually present a greater health and safety risk to abatement workers and building occupants. With specific EPA approval or a Site-Specific State Variance, the use of dry removal techniques may be granted.

The positive effects of wet removal can be further enhanced with the addition of a wetting agent (ie, surfactant) to the water. The wetting agent is one or more chemicals which, when added to water, causes it to penetrate more easily into, or to spread over the surface of, another material. Soaps, alcohols and fatty acids are some examples of wetting agents. Water with these additives is referred to as “**amended water**”.

The EPA recommends a wetting agent consisting of 50% polyoxyethylene ether in a ratio of 1 ounce to 5 gallons of water. Some wetting agents are not effective when used on materials which contain a high percentage of amosite asbestos. Therefore, care must be exercised to choose the correct additive for the material being wetted. Always read product MSDS sheets before handling or using any proposed wetting agent.

Removing Friable Insulation Materials from Ceilings

In New York State, the entire enclosure system, once completed, must be allowed to settle for at least four (4) hours prior to any Phase IIB abatement activities. This serves to verify that barriers will remain intact during the course of the project.

STEP 1: PRE-WETTING

The first in the removal process is to thoroughly wet the ceiling material with a *low* pressure spray of amended water. A sufficient amount of time must be allowed to ensure adequate penetration prior to removal.

If time permits, ceiling materials should be thoroughly saturated with amended water the night before removal starts.

STEP 2: GROSS REMOVAL

Gross removal is typically conducted with a three to four person team. Two individuals working from a mobile scaffold with rails remove the friable material using various scrapers. Workers of approximately the same height should be paired together on the scaffolds. One or two workers on the floor will place the wetted material in six mil. plastic bags or plastic-lined fiber drums before it has time to dry. Rubber dust pans, plastic shovels, push brooms, and rubber squeegees should be used to collect and bag the wet material. New York State regulations prohibit the use of metal shovels within the work area. ***Note: OSHA prohibits workers to remain on mobile scaffolding during relocation, provided certain conditions apply (29 CFR 1926.453(w)(6).***

During abatement, asbestos must never be dropped. In New York State, specific handling and removal procedures mandate the use for chutes when transferring asbestos waste distances greater than ten feet to a lower level. These chutes must be dust tight, enclosed and placed on an incline.

If several crews are removing materials, it may be time efficient to designate a “spray” person who walks from one area to the next, keeping the material on the ceiling and the floor wet and misting the air to maintain low airborne fiber concentrations. The floor person can also inspect for damaged floor barriers and promptly repair them (he/she should keep a roll of duct tape handy).

STEP 3: SECONDARY REMOVAL

After removing as much of the sprayed-on material as possible with scrapers, crews begin secondary removal. Depending on the type of substrate (material underneath the friable insulation), various techniques and tools may be required.

The surface substrate may be smooth, rough, or pitted and will affect the difficulty of secondary removal. Typically, a combination of brushing, wet wiping and HEPA vacuuming are used to remove the remaining residue. Nylon bristled brushes are favored over wire brushes. Wire brushes may actually cause small fibers to break into even smaller fibers. The rags used for wet wiping should be lint free and not leave any

fabric fibers on the substrate. Such fibers could be mistaken for contamination during a final inspection of the work area.

While crews are working from scaffolds or ladders to remove all remaining residue from the ceilings, workers should also be cleaning material off the plastic wall barriers and any stationary objects in the area. Brooms, wet rags or squeegees are good for this purpose. Secondary removal is finished when all visual contamination has been removed. The next phase is termed Post-Abatement Clean-Up.

Figure 9-2
Types of Ceiling Construction

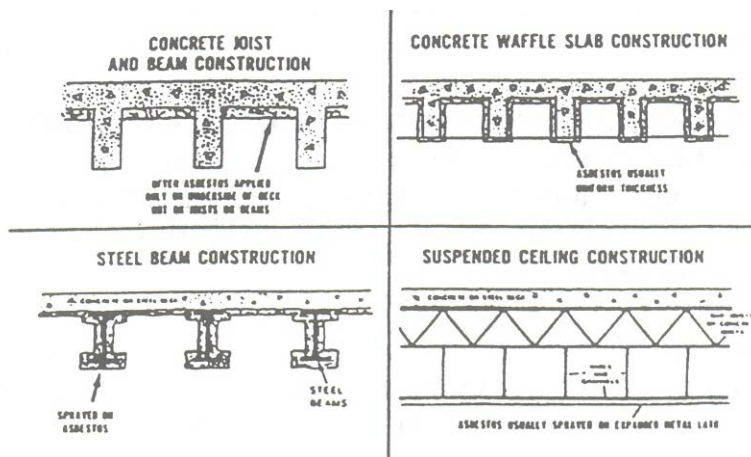

Removal of Insulation from Pipes, Boilers, and Tanks

There is a wide variation in the types of asbestos-containing insulation used on pipes, boilers and tanks. Pipes may be insulated with:

- Pre-formed fibrous wrapping
- Corrugated cardboard
- Chalky mixtures containing magnesia
- Fiber felt, tar-based wrap
- Insulating cement

Note: There are older materials labeled “*magnesia*” which contain asbestos and new materials also labeled “*magnesia*” which contain fibrous glass rather than asbestos.

Different approaches are required for removing these asbestos-containing materials than for spray-on or troweled-on ceiling insulations, but similar protective measures are used. Careful handling and containerization is required in many cases because of the metal jackets, bands, or wire often associated with the insulation materials.

Glove Bags, which can be sealed around sections of pipe to form a “mini-containment area” may be used in many situations for removing pipe insulations (refer to the discussion of glove bags elsewhere in this Section). Insulated objects, which are not

readily accessible, or are too large or hot for application of the glove bag technique, may require a tent set-up or a more conventional full-containment approach.

Because insulation on pipes, boilers and tanks often contain high percentages of asbestos (up to 70 % or greater) and areas where these materials are being removed are often confined, high airborne fiber concentrations may occur. Also, these materials are more difficult to saturate with water due to the fact that many of them contain amosite, a form of asbestos that is not easily wetted with amended water. For these reasons, Type C airline respirators are recommended for abatement workers engaged in the removal of asbestos from pipes and boilers.

STEP 1: PRE-WET & BAND REMOVAL

First mist the section to be removed with low-pressure amended water. Separate any metal bands that may be securing the insulation within that section (usually a three-foot section length). The metal bands or wire removed should be folded or rolled and placed in six mil. plastic bags to avoid injuring personnel.

STEP 2: SATURATE

Continue to saturate the outer covering (regardless if it is painted or not) to minimize fiber release.

STEP 3: SEPARATE INSULATION SECTION

Locate the section ends and using a utility knife or other sharp instrument, cut around the circumference at the end of the attached section while continually wetting the material with amended water. The approach is to isolate and work on one section at a time.

STEP 4: REPOSITION SECTION

The severed section is then carefully twisted to position one seam of the covering at the top of the pipe.

STEP 5: CUT AND OPEN

A length-wise cut is then made across the top of the covering. Each half is gently opened to expose the inner surface.

STEP 6: SATURATE OPEN SECTIONS

The exposed inner surfaces are then saturated with amended water. A sufficient amount of time must be allowed to ensure that the material is completely saturated prior to removal.

STEP 7: REMOVE AND BAG

Both halves of the insulation should be lowered and promptly bagged. After the gross material has been removed, nylon brushes and wet rags are used to thoroughly clean the pipes, tanks or boiler surfaces. Particular care must be exercised when cleaning the associated fittings and joints where cement-plaster type materials have been removed. A final clean-up phase is initiated.

Special Considerations

Amended water is not totally effective in controlling fibers emitted from material containing amosite asbestos. Some contractors have used ethylene glycol and/or oils to help reduce fibers generated from amosite. Others have tried an encapsulant, which is diluted so that it dries slowly and does not harden before the asbestos material can be removed from the pipes or boilers.

Steam or hot water distribution networks should be shutdown, if at all possible, prior to insulation removal. If these systems must stay on line, special consideration must be given to prevent heat stress by workers as well as measures to avoid skin burns. Insulating suits and gloves for use under these circumstances are available.

When airline type respirators are being used by workers, care must be taken not to let the airlines come into contact with hot pipes which could burn a hole in the rubber hoses. When airlines are worn by individuals working from scaffolds, care must be exercised no to entangle the airlines around objects on the ground or scaffold.

ENCAPSULATION TECHNIQUES

“Encapsulation.” It can be considered an abatement activity or “response action” in and of itself, but often is an adjunct procedure used during the final clean up of a removal project. It involves the spraying or brushing of a sealant to lock down (encapsulate) fibers onto a material’s surface and/or within the matrix of the material. The following factors must be addressed when considering encapsulation procedures:

1. The surface structure of the substrate
2. Suitability of the ACM to be encapsulated:
 - Adhesive characteristics
 - Cohesive characteristics
3. Type of encapsulant:
 - Bridging encapsulant
 - Penetrating encapsulant

1. Surface Structure

Some of the most common materials found as substrates to ACM applications in buildings include:

- Cement
- Corrugated Sheet Metal
- Wire Mesh
- Metal Piping
- Plaster
- Wood

Each of these materials has different surface structure characteristics, which play an important role in defining the bonding integrity of ACM and the use of encapsulants.

2. Suitability

The **adhesive** strength of a material are those forces which enable a material to bond to the substrate. **Cohesive** forces permit a material to bond to itself. The first decision a contractor must make when considering an encapsulation process is whether both the adhesive and cohesive forces, inherent in the asbestos material, will be strong enough to support the added weight of the sealant. In addition, the thickness of the ACM is an important factor to consider. If there is any doubt regarding the suitability of the base material to support the sealant, then the option of encapsulation should be re-considered. In New York State, whenever the contractor chooses this abatement option, a surface compatibility test of the encapsulant is mandatory.

3. Type of Encapsulants

Bridging encapsulants form a tough membrane over asbestos-containing materials. This membrane acts as a barrier, which is designed to prevent the future release of fibers. A penetrating encapsulate performs a similar function, but does so throughout the entire thickness of the material rather than just on the surface. It binds the asbestos fibers to one another as well as to other substances within the material.

New York State regulations stipulate that when using a bridging encapsulate, a different color encapsulate must be used for each coat applied.

Although penetrating sealants rarely contain pigments, many do contain dyes to color them. The addition of color helps to validate full-thickness penetration. Table 9-1 provides a comparison of the qualities inherent in both types of encapsulates and indicates conditions of use.

Table 9-3
Qualities of Encapsulants

Features	Bridging Encapsulant	Penetrating Encapsulant
Improves cohesive strength of material	No	Yes
Appropriate for material which adheres poorly	No	No
Appropriate for water-damaged material	No	No
Allows for fiber release if damaged	Yes	Sometimes
Impairs acoustic insulating properties of material	Yes	Yes
Preferable for cementitious materials	Yes	No
Appropriate for material which has already been painted or encapsulated	Yes	No

Reprinted with permission from Robert C. Twombly, Resource Management, Inc.

New York State regulations mandate the use of airless spray equipment for encapsulant application.

Additional selection criteria for encapsulates may include:

- The durability of the encapsulant to occasional abuse, without allowing the release of fibers.
- They must be water insoluble when cured.
- Must be able to accept recoating when necessary.
- The acoustical properties of in-place ACM should not be altered (in cases where this is a major consideration).
- If the in-place ACM has been used for fire retardation and/or protection of structural members, encapsulants must have high flame retardant and low toxic fume/smoke emission characteristics.

Application of Encapsulants

A. Encapsulation Equipment/Materials

In addition to standard removal equipment, the following items may be needed:

- Airless Spray Equipment (Various sizes of spray tips)
- Appropriate Encapsulating Agents
- Personal Protective Equipment
- Labels (to identify encapsulated ACM)

B. Work Area Preparation

As with all asbestos abatement operations, the work area must be properly prepared. Any damaged and/or missing areas of existing ACM must be repaired with a non-asbestos material. Loose or hanging asbestos materials must be removed using proper removal techniques (wet removal methods). Any repair materials used must be a suitable recipient for the application of encapsulating agents.

C. Worker Protection

Refer to the personal protective equipment section for standard worker protection protocols.

D. Application Methods

The pressure of the airless spray equipment should be adjusted to the lowest operable pressure. Often times, nozzle pressures may range between 400 to 1500 pounds per square inch, depending on which spray tip is chosen as well as the viscosity and solid contents of the encapsulant.

STEP 1: PRELIMINARY COAT

Apply an initial light (mist) coat of the encapsulant to the surface which helps to moisten and seal any loose surface fibers. Apply at a distance of approximately 18 to 24 inches from the surface.

STEP 2: SUBSEQUENT COATS

Upon completion of an area of approximately 16 to 20 square feet, apply a heavier coat of encapsulant at a distance of 10 to 12 inches from the surface and at a ninety-degree angle to the preceding coat. Each coat should be allowed to cure prior to the next application.

STEP 3: CLEAN-UP PROCEDURES

The clean-up procedures outlined in Section 10 should be followed. All encapsulated ACM must be properly labeled as such.

A record of the type of sealant used and the nature of the material and substrate encapsulated should be maintained as a part of an O & M program. All locations where ACM has been encapsulated must be conspicuously marked. Periodic inspections of all encapsulated ACM must be performed to ensure sealant integrity and ACM conditions.

Advantages and Disadvantages of Encapsulation

A. Advantages

- Controls fiber release.
- Can be used in conjunction with removal to ensure fiber lock-down.
- Initial cost may be lower than removal.
- Re-insulation cost is minimized or eliminated.

B. Disadvantages

- A source of potential asbestos exposure remains.
- Not suitable for all asbestos containing materials.
- Makes future removal more difficult and possibly more expensive.
- Periodic inspection and O & M will be necessary.
- All ACM must be labeled.
- A minimum of awareness level training will be required for building maintenance staff.

ENCLOSURE TECHNIQUES

Enclosure involves construction of *airtight* walls, ceilings and/or barriers around in-place ACM. It provided a physical barrier between the ACM and occupied spaces. The following factors must be considered prior to making the decision to enclose ACM:

- The underlying structures must be able to support new walls and ceilings.
- The feasibility of relocating electrical or plumbing lines, if necessary.
- Ducts and air plenums insulated with ACM must not be enclosed.
- Suitability of all surfaces and locations (exposure to wet environments or unacceptable obstructions to normal activities).
- An O & M program must developed to ensure the continued integrity of enclosures.

Enclosure Procedures

A. Work Area Preparation

The work area must be properly prepared following the standard work area preparation guidelines. Areas that may be disturbed during the installation of hangers or other support/framing materials for the enclosure must be sprayed with amended water. These areas must remain moistened during enclosure construction to reduce potential airborne fiber concentrations. All loose and/or hanging ACM must be removed (using appropriate removal techniques) prior to the construction of the enclosure. After installing hangers or other supports structures, but before installing enclosure materials, all damaged areas of fireproofing or thermal insulation must be repaired following acceptable practices, using acceptable replacement non-ACM materials.

If lights are recessed into ACM covered ceilings, they must be removed carefully to minimize fiber release (electric must be locked out). They can be reinstalled beneath the newly enclosed ceiling. Miscellaneous electrical and plumbing lines may require similar removal and installation.

B. Worker Protection

Refer to the personal protective equipment section for standard worker protection protocols.

C. Enclosure Construction Methods

STEP 1: ENCLOSURE DESIGN AND INSTALLATION

Each job must be viewed as a unique project. The main goal of enclosures is to create an airtight barrier between the ACM and occupied spaces. Suspended ceilings with drop panels are not considered acceptable enclosures.

STEP 2: CLEAN-UP PROCEDURES

Standard clean-up procedures should be followed.

Building records must note the presence of asbestos behind the enclosure to prevent accidental fiber release during remodeling or building demolition (the enclosure should be identified in the building O & M program). Signs and/or labels must be conspicuously posted, warning persons of the presence of enclosed ACM.

GLOVE BAG TECHNIQUES

Glove bags are available in a variety of sizes and configurations depending on specific applications requirements. While designed primarily as disposable units, some manufacturers have developed re-useable, hard-walled units. High temperature glove bags and many glove bag accessories are also available. Only individuals properly trained in the use and limitations of glove bag removal and the basics of respiratory protection may perform the removal using these techniques.

In NYS, individuals must have O & M certification at minimum, to perform glovebag operations.

Glove Bag Procedures

A. Work Area Preparation

Before work area preparation begins, all occupants must be vacated. The work area should be cordoned off and warning signs posted on the perimeter to minimize the chance of unauthorized visitors entering the area. Barrier tape (3 inch) with preprinted asbestos warning works well for training in emergency procedures in the event of a glove bag failure.

B. Worker Protection

Refer to the personal protective equipment section for standard worker protection protocols.

C. Glove Bag Methods

Two persons are required to perform proper Class I glove bag removal projects. Ideally, a third person should be available to assist with supplies, keep unwanted visitors out of the area and to conduct air monitoring (personal). Each of these individuals must have received formal training on the use and limitations of glove bag removal techniques. They must be included in the respiratory protection program and medical surveillance program. In NYS, they must be certified as Asbestos Handlers (O & M minimum).

Never perform glove bag removal on hot pipes (over 150 degrees) unless special materials and equipment, designed for such removals, are available.

STEP 1: PREPARE SURFACTANT MIXTURE

Mix the surfactant with water and place in the sprayer.

STEP 2: DON PPE

Put on a properly chosen respirator and a full-body disposable suit (***hood goes over the respirator straps***).

STEP 3: PREPARE WORK AREA

If the material adjacent to the work section is damaged (broken lagging, hanging piece, etc.), or if it terminates, is jointed or contains an irregularity adjacent to the work section, the material must be wrapped in at least six mil. fire retardant plastic sheeting and sealed airtight with duct tape. It should also be noted that loose pipe lagging several feet or even several yards away from the glove bag work may be jarred loose by the activity. Clean-up debris on the floor and other surfaces, which has accumulated and contains asbestos, prior to the start of removal.

Place at least one layer of duct tape around the pipe at each location where the glove bag will be attached.

STEP 4: CUT GLOVE BAG AS NECESSARY

Slit the top of the glove bag open (if necessary) and cut down the sides to accommodate the size of the pipe. **Note:** When abating pipe insulation, the pipe insulation diameter worked must not exceed one half the bag's working length.

STEP 5: PLACE TOOLS IN BAG

Place the necessary tools into the pouch located inside the glove bag. Cut out two donut shaped pieces of wettable plaster cloth with the inner diameter ½-inch smaller than the diameter of the pipe beneath the insulation. The outer diameter of the donut should be three inches longer than the diameter of the pipe insulation being removed. Wettable cloth is a plaster impregnated fiberglass webbing available at many hardware and/or plumbing supply stores.

Finally, cut a slit in each of the two donuts so they can be slipped around the pipe, and place in the tool pouch.

STEP 6: BAG RE-ENFORCEMENT

Place one strip of duct tape along the edge of the open top slit of the glove bag for reinforcement.

STEP 7: INSTALL BAG

Place the glove bag around the section of pipe to be worked on and staple the top together through the reinforcing duct tape, and at intervals of approximately one inch. Fold the stapled top flap back and tape it down with a strip of duct tape. Duct tape the ends of the glove bag to the pipe itself, previously covered with plastic sheeting or duct tape (see step 3).

STEP 8: INSTALL SPRAYER WAND AND HEPA VACUUM HOSE

Insert the wand from the water sprayer through the water sleeve. Using duct tape, tape the water sleeve tightly around the wand to prevent air leakage. Insert the hose from the HEPA vacuum through the second sleeve. Using duct tape, tape the sleeve tightly around the hose to prevent air leakage **Note: *These steps should be done before the glovebag is smoke tested.***

STEP 9: CHECK FOR LEAKS

Check the bag for leaks using a smoke tube and aspirator bulb. Use the HEPA vac. And collapse the bag. While the vacuum remains on, gently squeeze the aspirator bulb around the seams of the glove bag and look for smoke leaking into the bag. If leaks are found, they should be taped closed using duct tape and the bag should be re-tested with smoke.

STEP 10: PRE-WETTING INSULATION

One-person places his/hers hands into the long-sleeved gloves while the second person directs the water spray at the work.

STEP 11: CUT BANDS

Use the wire cutters to cut any bands and then use the tin snips to remove any aluminum jacketing. Fold sharp edges in order to prevent cutting the bag. Metal components can be placed in a burlap bag, which is inside the glovebag. The burlap bag will help minimize the risk of puncturing the glovebag and/or waste bag. ***Use caution to prevent cuts-these edges are sharp!***

STEP 12: SEPARATE SECTION

With the insulation exposed, use a bone saw or other tool to cut the insulation at each end of the section to be removed inside the glove bag. The second person should be wetting the insulation with amended water before, during and after this cutting process to keep fiber release to a minimum.

STEP 13: CUT SECTION OPEN

Once the ends are cut, the section of insulation should be slit from end to end using the utility knife. The cut should be made along the bottom of the pipe and water continuously applied.

STEP 14: REPLACE TOOLS IN POUCH

Spray all tools with water inside the bag and place back into the pouch.

STEP 15: REMOVE INSULATION SECTION

The insulation can now be lifted off the pipe and *gently* placed in the bottom of the bag.

STEP 16: REMOVE RESIDUE

Using the scrub brush, rags and water, scrub and wipe down the exposed pipe inside the glove bag.

STEP 17: PATCH OPEN ENDS

Place the donut-shaped pieces of wettable cloth (thoroughly wetted) over the exposed ends of the insulation remaining on the pipe.

STEP 18: REMOVE TOOLS

Remove tools from the tool pouch by putting them into glove, and pulling the glove outside the bag, turning glove inside out. Twist it to separate it from the bag. Place duct tape over the twisted portion and then cut the glove from the glove bag, cutting through the twisted/taped section. In this manner, the contaminated tools may be placed directly into the next glove bag without cleaning. Alternatively this pouch with the tools can be placed in a bucket of water, opened under water, and the tools cleaned and dried without releasing asbestos into the air.

STEP 19: COLLAPSE BAG

Turn on the vacuum only briefly to collapse the bag.

STEP 20: SEAL WAND SLEEVE

Remove the vacuum nozzle and twist the water sleeve closed and seal with duct tape.

STEP 21: TWIST AND TAPE BAG

With the removed insulation in the bottom of the bag, twist the bag several times and tape it to keep the material in the bottom during removal of the glove bag from the pipe.

STEP 22: LOWER GLOVE BAG INTO WASTE BAG

Slip a six mil. disposal bag over the glove bag (still attached to the pipe). Remove the tape and open the top of the glove bag (or cut it off the pipe) and fold it down into the disposal bag.

STEP 23: REMOVE COVERALL & SEAL WASTE BAG

Remove disposable suits and place into the disposal bag with the waste. Twist the top of the bag closed, fold this over, and seal with duct tape. Label the bag with a warning label as well as the name of the firm who *owns* the waste. (see Section 10)

STEP 24: REMOVE RESPIRATOR

Using a clean damp rag, wipe the exterior of the respirator and leave the work area. Remove the respirator. The respirator cartridges should be removed, sealed with duct tape and discarded as asbestos-containing waste.

STEP 25: DISPOSAL

All asbestos-containing material must be disposed of at an approval landfill in accordance with EPA regulations.

STEP 26: AIR SAMPLING (AS NEEDED)

Air sampling should be conducted before, during and after completion of glove bag projects to determine if undetected leakage occurred. This is mandatory in New York State only when the ACM to be removed by glove bag techniques exceeds the established criteria for Minor Projects. However, air sampling is required on a minor work area, if the minor is a part of a small or large size project. Additionally, air monitoring is required in the event of a tent or glove bag failure.

All air sampling and analysis must be performed by qualified individuals. Once the work area has met the criteria for re-entry by unprotected personnel, the barriers may be removed and re-insulation completed.

Figure 9-4 Diagrams Showing Proper Use of Glove Bags

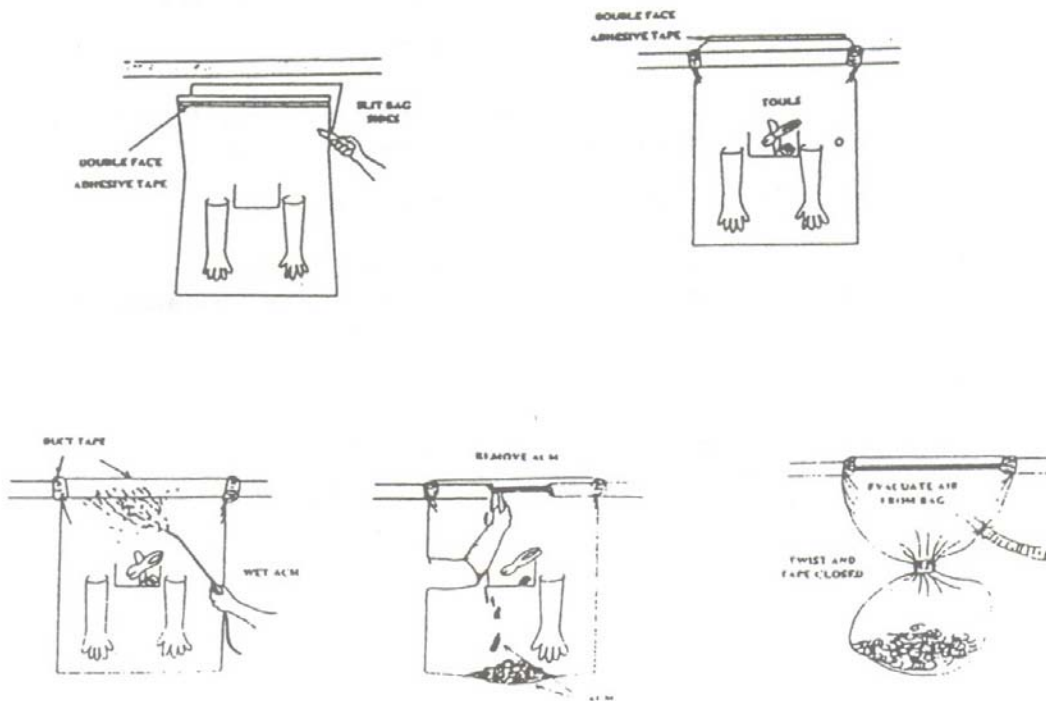

COMMON REMOVAL EQUIPMENT

- Barrier tape and signs

- Portable HEPA filtered exhaust units
- Replacement filters
- Flexible (reinforced) or rigid ducts
- HEPA equipped vacuum cleaners
- Electrical extension cords (OSHA approved)
- Heavy duty garden hoses
- Spray attachments for hoses (mistifiers or foggers)
- Hand pump garden sprayer
- Wetting agents (surfactants)
- Stiff scrapers in various sizes and lengths
- Nylon and wire brushes of various sizes
- Rags, towels and sponges
- Plastic dust pans
- Plastic shovels
- Long handled rubber squeegees
- Standard push brooms (must be used wet)
- Scaffolding with railings (refer to Section 11 for specific requirements)
- 6 ml. polyethylene disposable bags
- Wooden or fiberglass ladders
- Glove bags (for pipes) – see glove bag section equipment list
- Duct tape and spray adhesive
- Temporary lighting
- Ventilation smoke tubes and pressure manometers

SECTION 10 CLEAN-UP AND DISPOSAL

GENERAL CLEAN-UP TECHNIQUES

Clean-up procedures and techniques are detailed in NYCRR 56 and are described below. These procedures are required for all abatement projects, both large and small.

Containerization

Clean up of accumulations of loose asbestos material shall be performed whenever enough loose asbestos material has been removed to fill a single leak tight container of the type commensurate with the material properties. In no case shall clean up be performed less than once prior to the close of each working day. Asbestos material shall be kept wet until cleanup.

Dust

Accumulations of dust shall be HEPA vacuumed and/or wet cleaned off all surfaces on a daily basis, using HEPA vacuum and/or wet cleaning methods.

Enclosures

Decontamination enclosures shall be HEPA vacuumed and/or wet cleaned at the end of each shift.

Tools and Equipment

Accumulations of asbestos waste material shall be containerized utilizing HEPA vacuums or rubber or plastic dustpans, squeegees or shovels. Metal shovels shall not be used to pick up or move waste.

POST ABATEMENT REQUIREMENTS

The following procedures are required after completion of all abatement activities.

STEP 1: TOOLS AND EQUIPMENT

All accumulations of asbestos waste material shall be containerized utilizing HEPA vacuums or rubber or plastic dustpans, squeegees or shovels. Metal shovels shall not be used to pickup or move waste. HEPA vacuums shall be used to clean all surfaces after gross cleanup.

STEP 2: FIRST CLEANING

All surfaces in the work area shall be first wet cleaned using rags, mops and sponges. *To pick up excess liquid and wet debris, a HEPA equipped wet-purpose shop vacuum may be used and shall be decontaminated prior to removal from the work area.* In accordance with New York State Code Rule 56-9.1(b) upon completion of first cleaning a thin coat of lockdown encapsulant agent shall be applied to all surfaces within the regulated abatement work area which were not the subject of abatement or removal.

STEP 3: FIRST SHEETING REMOVAL AND SECOND CLEANING

After the first cleaning, the appropriate number of hours shall be observed to allow for asbestos to settle. The cleaned, exposed barrier layer of plastic sheeting shall be removed from walls and floors. All surfaces in the work area will be cleaned a second time, using wet methods/HEPA Vac. Windows, doors, HVAC system vents and all other openings shall remain sealed. Decontamination enclosure systems shall remain in place and be utilized.

STEP 4: SECOND SHEET REMOVAL AND THIRD CLEANING

After the second cleaning and after the appropriate waiting time has elapsed for asbestos to settle, the remaining plastic on the ceiling, walls and floors only, shall then be removed. All windows, doors, HVAC system vents and all other openings shall remain sealed. Thereafter, all objects and surfaces in the work area shall be HEPA vacuumed and/or wet cleaned a third time.

STEP 5: REMOVAL OF WASTE

All containerized waste shall be removed from the work area and the holding area.

STEP 6: REMOVAL OF TOOLS AND EQUIPMENT

All tools and equipment shall be removed from the work area and decontaminated.

STEP 7: CLEARANCE AIR MONITORING

Clearance air monitoring, as per the schedule for air sampling and analysis, shall be conducted.

STEP 8: REMOVAL OF ISOLATION BARRIERS

The isolation barriers shall be removed only after satisfactory clearance air monitoring results have been achieved.

DEMOLITION REQUIREMENTS

The following clean-up procedures shall be required for demolition projects:

STEP 1: METHODS, TOOLS AND EQUIPMENT

All accumulations of asbestos waste material shall be containerized and removed. Metal shovels may be used to pickup or move waste except in the vicinity of any isolation barriers, which could be breached. The areas around isolation barriers shall be cleaned utilizing rubber or plastic dustpans, squeegees or shovels. To pickup excess liquid and gross wet asbestos waste material, a wet-purpose shop vacuum may be used and shall be decontaminated prior to removal from the work area.

STEP 2: REMOVAL OF WASTE

All containerized waste shall be removed from the work area and the holding area.

STEP 3: SURFACE CLEAN UP

All surfaces in the work area shall be wet cleaned using rags, mops and sponges. HEPA vacuums shall be used to clean all surfaces after gross clean up.

STEP 4: SHEETING REMOVAL

Where porous floor or cinderblock-like materials have been plasticized for surface barrier containment, each layer of plastic in succession shall be cleaned as above, sprayed with a thinned encapsulant and removed when dry.

STEP 5: REMOVAL OF TOOLS AND EQUIPMENT

All tools and equipment shall be removed from the work area and decontaminated as described above.

STEP 6: CLEARANCE AIR MONITORING

Clearance air monitoring, as per the schedule for air sampling and analysis, shall be conducted.

STEP 7: REMOVAL OF ISOLATION BARRIERS

The isolation barriers shall be removed only after satisfactory clearance air monitoring results have been achieved.

MINOR ASBESTOS PROJECTS

If a glove bag or tent is used and fails or loses its integrity, the following procedures shall be required:

STEP 1: ISOLATION BARRIER CONSTRUCTION

An Isolation Barrier shall be constructed as follows:

- *HVAC Isolation* - The HVAC systems shall be shut down immediately and all openings shall be sealed with at least six-mil fire- retardant plastic sheeting and duct tape.
- *Uncontaminated Areas* - Passageways to uncontaminated areas of the building or structure shall be sealed with at least six-mil fire-retardant plastic sheeting and duct tape.

STEP 2: NEGATIVE AIR PRESSURE VENTILATION

Negative air pressure equipment ventilation shall be installed and utilized.

STEP 3: CLEAN UP

Clean up shall be accomplished in accordance with Code Rule 56-8.2(g) as follows:

- *Method, Tools and Equipment* - All accumulations of asbestos waste material shall be containerized. Non-metal shovels and HEPA vacuums may be used to pick up or move waste except in the vicinity of any isolation barriers, which might be breached. The areas around the isolation barriers shall be cleaned utilizing rubber or plastic dustpans, squeegees or shovels. HEPA vacuums shall be used to clean all surfaces after gross clean up.
- *Clean up of Surfaces* - All surfaces in the work area shall be first wet cleaned using rags, mops and sponges.
- *Second Cleaning* - After the first cleaning at least 12 hours shall be observed to allow for asbestos to settle. Thereafter, all objects and surfaces in the work area shall be HEPA vacuumed and wet cleaned. All windows, doors, HVAC system vents and all other openings shall remain sealed.

STEP 4: REMOVAL OF CONTAMINATED EQUIPMENT AND WASTE

All remaining contaminated equipment and all containerized waste shall be removed from the regulated abatement work area.

STEP 5: CLEARANCE AIR MONITORING

Clearance air sampling shall be conducted, as per the schedule for air sampling and analysis,

STEP 6: REMOVAL OF ISOLATION BARRIERS

The isolation barriers shall be removed only after satisfactory clearance air monitoring results have been achieved.

WASTE DECONTAMINATION AND DISPOSAL

Large Asbestos Projects:

All external surfaces of contaminated bags, wrapped debris, equipment and tools shall be wet cleaned and/or HEPA vacuumed in the work area prior to moving them into the waste decontamination enclosure system airlock by persons assigned to this duty. These work area persons shall remain in the work area and not enter the airlock.

Contaminated items shall be removed from the airlock by persons stationed in the washroom during waste removal operations. These washroom persons shall remove gross contamination from the exterior of their respirators and protective clothing by brushing, HEPA vacuuming and/or wet cleaning.

Once in the waste decontamination enclosure system, external surfaces of contaminated items and equipment shall be cleaned a second time by wet cleaning.

The cleaned items and equipment are to be dried of any excessive pooled or beaded water and placed in uncontaminated plastic bags or sheeting. The bags or sheeting must then be placed in a hard container appropriately labeled to prevent puncture or tearing of the plastic bags or sheeting. The hard containers must then be wet wiped.

The containers shall then be moved into the air-lock that leads to the holding area. The washroom persons shall not enter this airlock or the work area until waste removal is finished for that period.

Containers and equipment shall be moved from the airlock and into the holding area by persons dressed in clean personal protective equipment, who have entered from uncontaminated areas.

The cleaned containers of asbestos material and equipment shall be placed in watertight carts with doors or tops that shall be closed and secured. These carts shall be held in the holding area pending removal. The carts shall be wet cleaned and/or HEPA vacuumed immediately following the removal of asbestos material from them.

The exit from the decontamination enclosure system shall be secured to prevent unauthorized

entry.

Where the waste removal enclosure is part of the personal decontamination enclosure, waste removal shall not occur during shift changes or when occupied.

Small Asbestos Projects:

Where only one exit exists and the shower is used as a waste removal washroom, persons shall be stationed in each area of the decontamination enclosure to transfer, as in a large asbestos project, the contaminated containers and equipment through adjacent areas. These persons shall not cross the airlocks into the adjacent areas until the waste removal is finished for that period and all other persons have been decontaminated. The clean room/holding area persons shall enter from uncontaminated areas dressed in clean personal protective equipment.

The decontaminated containers must be placed in carts that are watertight and have doors or tops that shall be closed and secured. The carts shall be HEPA vacuumed and/or wet cleaned immediately following the removal of asbestos material from them.

All waste generated as part of the asbestos project shall be removed from site within ten (10) ten calendar days after successful completion of phase II-C for all regulated abatement work areas at the site per 56-10.4 of New York State Code Rule.

Waste Load-Out

When the containerized material is ready to be loaded on the truck for transport to landfill, the following procedure shall be followed:

1. The truck shall be lined with 2 layers of 6 mil plastic on the bed. Plastic should extend up the walls of truck at least 6 inches.
2. Truck walls must then be plasticized with 2 layers of 6-mil poly with staggered seams.

Once the truck has been properly prepared, waste can then be loaded from the holding area into the truck by persons wearing clean protective clothing and respirators. Carts, which held the containers of waste must be HEPA, vacuumed and/or wet cleaned following transfer of containers to the truck. After the truck has been loaded and properly placarded (per DOT requirements), waste can be transported to an EPA approved landfill for disposal.

WASTE SHIPMENT

All shipments of asbestos containing waste material must be accompanied by a Waste Shipment Record (WSR). When it is signed by the generator, the transporter and the waste disposal site operator, the WSR documents the movement and ultimate disposition of asbestos waste. The WSR consists of three parts and requires, three signatures, those of the generator, the transporter and the disposal site operator.

1. Waste Generator

Waste generator means an owner or operator of a source whose activities produce asbestos-containing waste materials. Included are asbestos mills, manufacturers, fabricators, demolitions, renovations and abatement operations. The original WSR, prepared by the generator, should be turned over to the transporter along with the waste shipment, although the generator should retain a copy of the WSR signed by the transporter acknowledging receipt of the waste shipment for his records.

Category I non-friable materials (asbestos containing packings, gaskets, resilient floor covering and asphalt roofing products) should be considered non-friable if they have not been sanded, ground, burned, or abraded.

Category II non-friable materials (non-friable materials that are not in Category I) such as asbestos-cement products, may be reported as non-friable also.

The quantity of waste must be listed in cubic meters or cubic yards. Quantities may be reported in the units that you are most comfortable using, but you are expected to make a good faith effort to report correctly. Some helpful conversion factors are provided below:

- Drums and barrels used as asbestos-waste containers are typically of 35 gallons capacity. Gallons can be converted to cubic yards by multiplying gallons by 0.00379. In this example, $35 \text{ gallons} \times 0.00379 = 0.133 \text{ cubic yards}$ for the volume of 35 gallon drum or barrel.
- Asbestos waste bags have a nominal volume of 0.1 cubic yards, but when they contain asbestos waste, their volume is assumed to be about 0.075 cubic yards.
- Cubic yards can be changed to cubic meters by multiplying cubic yards by 0.765. A 35-gallon drum with a calculated volume of 0.133 cubic yards would have a volume of $0.133 \times 0.765 = 0.102 \text{ cubic meters}$. When the waste is turned over to the transporter, the transporter should be required to acknowledge receipt of the asbestos waste by signing the WSR, with a copy of the WSR signed by the transporter retained by the generator.

2. Transporter

At the time the transporter takes possession of the load of waste, the generator shall supply a WSR. The transporter should acknowledge receipt of the asbestos waste by signing the WSR, returning a copy of it to the generator. If the shipment is turned over to a second transporter, this transporter should acknowledge receipt of the shipment by also signing the WSR. It is recommended that a copy of the signed document be retained by the initial transporter when the WSR is surrendered to a second transporter. The transporter who delivers the waste shipment to the waste disposal site should surrender the WSR to the disposal site operator. It is recommended that a copy of the WSR signed by the disposal site operator be retained by the transporter as a matter of good business practice.

3. Disposal Site Operator

Waste disposal site operators are not expected to open bags or other containers to verify that the material is asbestos: if a WSR accompanies the shipment that is sufficient verification. The disposal site operator should check to see that the numbers of containers reported in WSR and the quantities reported in WSR appear to be correct.

Transportation of Asbestos Containing Waste

Preparing For Shipment

- *Wetting* - Asbestos waste must be sufficiently mixed with water, or a wetting agent recommended by the manufacturer, to effectively wet dust and tailings so as to prevent visible dust emissions.
- *Packaging* - All waste must be sealed in leak-proof containers while wet. Drums and containers are often used to transport asbestos waste.
- *Labeling* - All bags and containers must be labeled with the following warning:

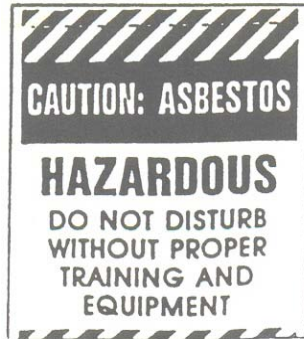

In addition, each bag of asbestos waste must be permanently labeled with the following generator information:

GEN NAME:	ABC Company
LOCATION:	Rochester, NY
JOB NUMBER:	ABC123
DATE:	9-5-93
LIC #:	AC-92-0803

All vehicles used to transport asbestos waste must be in compliance with DOT requirements. If carrying more than 1001 pounds of ACM, the appropriate placards should be placed on all four sides of the vehicle:

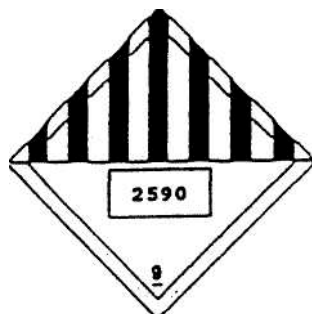

White Asbestos

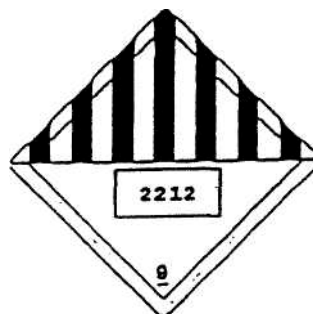

Blue, Brown, or Unidentified Asbestos

Uncontaminated containers may be reused. Containers which are used to transport asbestos waste and which become contaminated shall be disposed of with the asbestos waste. Drums, which have become contaminated, should be emptied, crushed and disposed of with the asbestos waste.

Disposal Site Operations

Assuming the asbestos renovation debris has been removed and packaged in accordance with EPA and OSHA requirements, it may be disposed at a sanitary landfill, providing that the following measures and precautions are taken to prevent the asbestos fibers from becoming airborne:

1. The hauler, having a permit pursuant to 6 NYCRR Part 364 (industrial waste hauler permit regulations), should first inform the landfill operator of his intent to dispose of asbestos-containing waste, the volume of waste, and the anticipated date.
2. The landfill operator should then direct the hauler to the selected disposal area. This

area should be recorded so that in case of any future construction activity in the area, necessary precautions can be taken to handle the material in a safe manner.

3. Drums will often be used to transport the asbestos waste. Uncontaminated drums may be reused; contaminated drums, however, should be emptied, crushed and disposed with the other asbestos material.
4. The waste material may be placed into a pre-dug trench in the existing refuse, provided the five feet groundwater separation distance, as required by solid waste regulations, is adhered to. This would enable the operator to simply backfill with at least three feet of refuse (could be waste material excavated from the trench) before compaction. The intent of the three feet of refuse is to bridge the asbestos-containing bags, and to add a buffer material between compaction equipment. If it is believed by the operator that additional refuse should be placed over the asbestos waste before compaction to adequately separate his equipment from the asbestos, then he may, by all means, take this precaution. At the end of the operation, the appropriate cover material (daily, intermediate, final) should immediately be applied.
5. The waste material may be placed into a trench at the landfill site apart from the previously filled refuse providing, again, five feet groundwater separation is maintained. The waste material shall be covered with at least 18 inches of soil cover before compaction. As in the case of the three feet of refuse, the soil cover is intended to bridge the asbestos-containing bags, and to add a buffer material between the asbestos and the tracks or wheels of the compaction equipment. Six inches of daily cover should be applied, as required.
6. If the waste cannot be trenched, or if the landfill operator does not wish to use either of these trenching techniques, the material could be placed at the bottom of the working face and covered with three feet of refuse before compaction. The six-inch daily cover should be applied as usual.
7. In rural areas in which landfills may not receive sufficient volumes of refuse to provide the recommended three feet of refuse for cover before compaction, either of the trench methods should be used. If a trench method is not used, then 18 inches of soil cover could be substituted for the three feet of refuse. In this latter case, the asbestos waste should be placed at the working face at the end of the day, the 18 inches of cover materials applied to the waste before compaction, and then after compaction, the required daily cover placed over the entire day's refuse.

In summary, the above-recommended procedures are intended as minimum precautionary measures for the protection of landfill personnel and the proper disposal of asbestos-containing material.

If the operator and/or the inspector believes that these requirements are insufficient to prevent the asbestos material from becoming airborne, or coming in contact with landfill equipment because of site-specific conditions or otherwise, added precautions should be taken.

REPORTING REQUIREMENTS

The NESHAP includes reporting requirements for generators and waste disposal site operators. Generators are required to submit exception reports if they do not receive a copy of the WSR signed by the disposal site owner or operator within 45 days of the date the shipment was accepted by the first transporter. Disposal site operators must file reports of discrepancies between the quantities of waste indicated on the WSR and the quantities actually received, as well as reports of improperly enclosed or uncovered waste.

Exception Report

If a generator of a shipment of asbestos waste does not receive a copy of the WSR signed by the disposal site operator within 45 days after turning the waste over to the first transporter, the following steps must be taken to locate the waste shipment:

- First, contact the transporter and verify the fact that the waste was delivered to the waste disposal site specified in the WSR. If the transporter has not delivered the shipment, determine the reason for the delay, and when it will be delivered.
- If the transporter has delivered the waste to the specified waste disposal site, inquire if a copy of the WSR signed by the disposal site operator can be made available to you. (The transporter is not required to obtain or keep a copy signed by the disposal site operator; however, some may do so as a matter of good business practice.)
- Next, contact the disposal site operator and determine why you have not received a copy of the WSR signed by him. Request that the disposal site operator send a signed copy of the WSR to you immediately.
- If a signed WSR from the disposal site operator is not received within 45 days after waste has been turned over to the initial transporter, the generator must submit a written exception report to the responsible NESHAP program agency. The report should include a copy of the WSR in question as well as a cover letter that explains what has been done to locate the shipment, and results of this search.

Discrepancy Report

Waste disposal site operators will check the WSR that accompanies each asbestos waste shipment that arrives at the site to make sure that the information on the WSR accurately describes the waste shipment. If a discrepancy exists between the number of containers shown on the WSR and the number in the truck, this will be noted in the WSR and the generator will be contacted to determine if there is a reasonable explanation for the discrepancy. If the apparent discrepancy cannot be resolved, it will be noted on the WSR and forwarded to the generator.

If the discrepancy cannot be resolved within 15 days of accepting the waste, the disposal site

must send a written discrepancy report immediately to the responsible agency in whose jurisdiction the generator of the waste is located. The discrepancy report will describe the discrepancy in question and the steps taken to obtain an explanation for it, such as how and when attempts were made to reach the generator. A copy of the shipment's WSR must accompany the discrepancy report.

Report of Improperly Enclosed or Uncovered Waste

Disposal site operators will check asbestos waste shipments arriving at their sites and are expected to look for significant amounts of improperly enclosed or uncovered waste before the material is disposed of. If significant amounts of improperly enclosed or uncovered waste are discovered in a shipment, it will be noted on the WSR and sent by the following working day, along with a written report of the problem to the specific agency responsible for administering the NESHAP program for the jurisdiction where the job site is located. The written report should describe the improperly enclosed or uncovered waste in sufficient detail that the responsible agency can determine the urgency of the situation and what action to take.

It should also be noted that disposal site operators may refuse to accept such loads of waste, requiring the transporter to return the waste shipment to the generator.

RECORDKEEPING REQUIREMENTS

There are specific recordkeeping requirements for waste generators and waste disposal sites. Generators must keep copies of all WSR's for at least 2 years. In addition to keeping WSR's for at least 2 years, active waste disposal sites must also keep records of the asbestos-containing waste material located within the site.

Waste generators must retain copies of each WSR, including WSR's signed by the owner or operator of the waste disposal site where the waste was deposited, for at least 2 years. The WSR's should be kept in chronological order in a secure, watertight file. Generators are expected to provide copies of WSR's upon request of the responsible agency and to make the WSR file available for inspection during normal business hours.

SECTION 11 GENERAL SAFETY CONSIDERATIONS

INTRODUCTION

Electrocution and electric shocks are among the most common hazards and provide the least warning. Use of wet methods increases the potential for electric shock, from working around panels, conduits, light fixtures, alarm systems, junction boxes and computers.

Incorrect wiring, improper grounding and lack of proper insulation result in over 1,000 people being electrocuted each year, many from contact with only 120 VAC.

WORKER RESPONSIBILITIES

Workers may not be held responsible for all electrical preparations, but wisely are responsible for:

- Being aware of possible hazards.
- Knowing how hazards should be treated.
- Knowing what to do to protect themselves from electrical shock while working in an abatement area.

STEPS FOR REDUCING ELECTRICAL HAZARDS

Note: It is important to identify and guard against hazards before starting any asbestos removal work.

1. Inspect for wiring faults, such as open ground paths, reverse wiring polarity, “hot” neutral or “hot” ground wires.

Note: Any faults discovered must be repaired for safety reasons.

2. Remove all electrically powered equipment, machinery, and lighting prior to starting work, whenever practical.
3. Be certain that any damaged fixtures or electrical equipment that cannot be removed are repaired to safe operation, or are disconnected, locked out and identified as damaged with warning labels.
4. Protect cables, lines and outlets. Utilize “hot line” covers over any energized cables or power lines, when possible. Tape over and seal all electrical outlets to avoid water getting into them. If electrical circuits, machinery and other electrical systems in or passing through the regulated abatement work area

must stay in operation, the procedures for plasticizing and labeling must be followed, as outlined in NYCRR 56-7.7.

5. Turn off, lock out and tag out all circuits leading into the project area. If electrical disconnects (open or locked out) are not readily visible for circuits in excess of 600 volts, they should be installed and tagged out according to company rules.
6. Assign a "Responsible Person" to:
 - Make visual inspections and tests to assure de-energizing of lines and equipment.
 - Report to the supervisor that all switches and disconnects have been de-energized, locked out and plainly tagged at the end of the project.
 - Confirm that all crewmembers are clear before tags and lockouts are removed.
 - Ensure that a separate tag and lockout are provided for each crewmember requiring de-energizing of the same line or equipment.

LIGHT AND POWER INSIDE AN ABATEMENT AREA

Use of electric power in asbestos work sites is regulated under the OSHA Asbestos Standard, OSHA Lockout/Tagout Standard and NYS Code Rule 56. Key aspects include:

1. Use of portable flood light systems for lighting
2. Use of Ground Fault Circuit Interrupters (GFCI).
 - A GFCI must be used on each circuit to provide safe power supplies.
 - Keep GFCI's outside the enclosure and away from high humidity.
3. Use extension cord and wiring safely. They must be three-conductor type and ground wire conductivity must be verified.
 - Power must be supplied through a GFCI located at the power source.
 - Do not string electrical wiring or extension cords across floors. They could be easily damaged and are tripping hazards.
 - Hang wiring up on walls whenever possible, but do not staple them in place or hang from nails or other sharp objects.

4. Establish a company equipment-grounding program.
 - The program must include required regular inspection of all electrical tools, cords and other devices. Written records of the inspections should be kept.

CONSIDERATIONS WHEN OTHER PARTS OF THE BUILDING ARE OCCUPIED

Abatement projects in occupied buildings are common. As a consequence, electrical conduits and equipment inside a work area may have to be left on to provide power to occupied parts of the building

Special caution must be taken if panels and transformers must be left uncovered due to possible heat build up.

Dry asbestos removal methods may be used if absolutely necessary. A special variance from Code Rule 56 must be obtained if that is so.

ELECTRICAL SAFETY CHECKLIST

1. The use of wet methods increases the potential for electrical shock when working around electrical panels, conduit, light fixtures, alarm systems, junction boxes, computers or transformers.
2. De-energize as much equipment as possible. Use portable flood light systems for lighting and regularly check the system and its wiring for damage.
3. Consider using dry removal in areas immediately adjacent to energized electrical equipment if de-energizing is not feasible. (Must get a variance for dry removal.)
4. Use non-conductive scrapers and vacuum cleaner attachments (wood, plastic, rubber).
5. Supply workers with insulated rubber boots and/or gloves when they are working around energized wiring or equipment.
6. Use "hot-line" covers over energized cables and power lines, whenever possible.
7. Make sure all electrical equipment is properly grounded before the job starts. This means checking outlets, wiring, extension cords and power

pickups. Check for the ground-pin on all plugs. These checks should also be made while setting up and during the job.

8. Take care not to damage insulated wiring with scrapers. Rolling a heavy cart or scaffold over a wire can cause invisible internal damage.
9. Do not let electrical wiring lie on the floor. Elevate the wiring to keep it away from water on the floor and from possible damage caused by foot traffic or rolling scaffolds.
10. Do not allow water puddles to form on work area floors. (Some removal contract specifications allow damp floors but not puddles.)
11. Make sure electrical outlets are tightly sealed and taped over to avoid water entry.

TOOLS AND EQUIPMENT ON ABATEMENT PROJECTS

Power tools:

Must be equipped with a 3-wire cord and have a grounding wire permanently affixed to the tool frame.

- Must be double insulated type and labeled as such.
- Must be fitted with a vacuum device with HEPA filters.
- Must be inspected regularly for damage, proper grounding and integrity of insulation.

LADDERS AND SCAFFOLDS

Fiberglass ladders:

- Ladders that may conduct electricity are prohibited from use.
- Preferably use fiberglass ladders which will not allow grounding if workers using them should contact an energized circuit.

The use of ladders and scaffolds is necessary for many abatement and inspection tasks and may present special hazards because of:

- Wet, slippery, polyethylene covered floors and wet ladder rungs
- Bulky protective clothing
- Unstable work surfaces
- Inadequate lighting
- Tool use

Ladder Maintenance

- Keep all ladders and scaffolds well maintained.
- Inspect all ladders and scaffolds periodically.
- Do not improvise repairs. Do not use duct tape or other similar materials to hold broken ladders together.
- Immediately destroy or discard defective ladders.
- Be sure that ladder safety feet spreaders and all components of extension ladders are in good condition.
- Check all movable parts. They should operate easily, without binding or undue looseness.
- Keep ladder rungs free from grease or oil.
- Be sure that hook type or other ladders are positively fastened (“tied off”) when in use.

Proper Ladder Use

- Use ladders only for their intended purpose.
- Use extension type ladders at a 1-4 lean ratio.
- Use stepladders only when they are fully opened and locked in place.
- Face any ladder while going up and down on it.
- Do not use the very top step of any ladder. Get a longer ladder instead.
- Objects, including tools, should not be stored on the top or any step of a ladder.
- Do not use the bracing on the back legs of stepladders for climbing.
- Portable ladders are not intended for group use. (One person to a ladder.)
- Use fiberglass ladders whenever possible to avoid the potential electrical hazards of metal ladders.

Scaffolds

Specific OSHA standards apply to the use of scaffolding, which must be reviewed prior to construction or use. Key requirements include:

1. The height of a manually propelled mobile scaffold cannot exceed 4 times it’s minimum (smallest) base width or length. This is because scaffolds can be easily tipped over when moved (see Figure 11-1).
2. When using motorized mobile scaffolding, follow its manufacturer’s recommendations.

3. Workers may not ride on manually propelled mobile scaffolding while it is being moved.
4. Inspect all scaffolding components prior to use:
 - The wheels should turn freely and be well lubricated.
 - Platform planking should be already available before scaffold is assembled
5. Keep debris off the floor where mobile scaffolds will be used. The additional force required moving a scaffold if a wheel catches on debris may be all that is needed to tip it over.
6. Guard rails:
 - Should always be installed on scaffolding used for abatement projects.
 - OSHA requires that guardrails must be used when scaffolding is from 4 to 10 feet tall and less than 45" wide and must be used when scaffolding is taller than 10 feet.
7. Planking:
 - Planking used on the scaffold should not extend more than 12" past the edges, and should always be secured to the frame.
8. Kickplates:
 - Kickplates should be used regardless of scaffolding height to keep tools, etc., from being knocked off and hitting someone.
9. Hard Hats:
 - When scaffolds or ladders are in use, approved hard hats must be worn by all workers to prevent injury from falling objects.

SLIPS, TRIPS AND FALLS

Even areas properly constructed and maintained for asbestos removal present some special safety hazards.

1. The floor of the work area is covered with polyethylene, which is very slippery when wet.
2. Air and electrical lines create trip hazards if they are on the floor.

3. The feet of disposable protective coveralls can easily slip on wet polyethylene. Possible safeguards for workers may include:

- Rubber boots with non-skid soles.
- Slip-on shoes with non-skid soles.
- Safety shoes with non-skid soles.

PREVENTING SLIPS, TRIPS AND FALLS

After asbestos and other debris are removed, they should be bagged, taken off the floor and stored out of the way as soon as possible. This may require some extra effort but the work area will be much safer.

No running, jumping or “horseplay” should ever be allowed in the work area. Such activities greatly increase the risk of injury from falls.

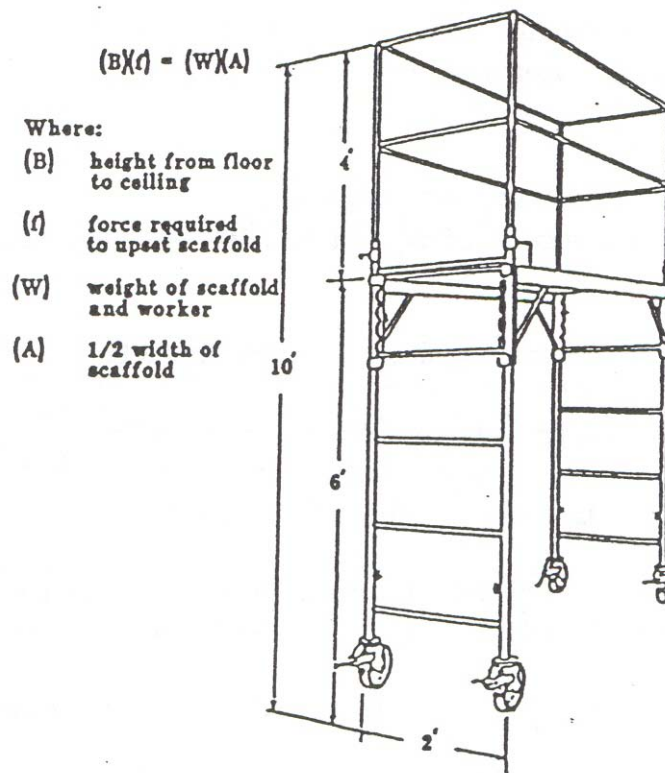

Figure 11-1
Scaffold Upset Formula

FIRE PREVENTION

Special Fire Hazards

- The enclosed work area makes escaping difficult.
- Bulky protective clothing interferes.
- Polyethylene and protective clothing can catch fire.

All of these present special fire hazards, which may interfere with emergency response.

Enclosed Work Area Hazards

Sealing off an area and blocking entrance/exit openings may conflict with OSHA, NFPA and local fire code requirements.

1. A pre-work fire safety survey should determine:
 - Potential fire hazards
 - Sources of fire hazards
 - “Hot-spots”
 - Location of exits
 - The number of workers to be in the area
 - The types and amounts of any combustible/flammable materials that must remain on site.
2. Remove all possible sources of ignition that could start a fire.
 - Be sure that gas and other fuel sources are cut off and that pilot lights on boilers, heaters, hot water tanks and compressors are extinguished.
 - Do not allow lighters or matches in the work area.
3. Drape certain equipment (computers, terminal boards, switch panels, transformers) with fire blankets instead of sealing it off, in order to prevent overheating.
4. Cut off the source of supply to steam lines, electric and steam heaters, and radiators.
5. Safe use of oxygen/acetylene torches:
 - Post a fire watch, with an appropriate fire extinguisher such as pressurized water, CO₂, or dry chemical.
 - Know what is on the other side of the wall and below the floor in case it could be affected by the torch flame.
 - Use either sheet metal or treated tarpaulin to catch any sparks.

6. Flammable/combustible materials:
 - Reduce the amount of flammable/combustible materials inside a space to a minimum, prior to hanging any plastic.
 - Remove chemicals, flammable liquids or any other heat sensitive materials. Keep flammable trash and debris to a minimum.
7. Flammable vapors:
 - Be alert for flammable vapors commonly present in industrial areas or during mastic removal operations (solvents such as naphtha, toluene or xylol). This is especially critical in vacuuming operations because vacuum motors may not be explosion proof (compressed air vacuums may be required instead).

PROTECTIVE CLOTHING AND POLYETHYLENE

Protective Clothing

Some protective clothing can burn and melt quickly. The material can shrink or drip and adhere to skin as it burns. It also gives off heavy black smoke.

Polyethylene

Polyethylene is combustible (even fire retardant poly). It will start to burn slowly and pick up speed as more heat is generated. It gives off heavy and highly toxic smoke as the fire progresses.

Polyethylene sheeting should be kept away from heat sources such as transformers, steam pipes and boilers that must remain hot during the removal project. Polyethylene and duct tape especially should not be allowed to contact surfaces that are above 150 degrees Fahrenheit.

FIRE EMERGENCY PROCEDURES

OSHA requires a written emergency action fire prevention plan.

All workers must be advised of and understand their roles in the plan, prior to beginning work. Such understanding must include:

- The manner in which emergencies are communicated (ie, announced).
- Emergency escape procedures and emergency escape routes.
- Procedures for any employee who must stay back to deal with critical plant operations, which may take time to safely shut down.
- Procedures to account for all employees after evacuation.
- Rescue and medical duties.

- Names and/or job titles of people to be contacted for additional information.
- A list of major workplace fire hazards.
- Names and/or job titles of people responsible for periodic inspection and maintenance of fire prevention equipment.
- Names and/or job titles of people responsible for control of fuel source hazards.

The Emergency Plan Must Establish Exits

Considerations for establishing fire exits should include:

- If the work area is large and many workers are present, several emergency exits may be needed.
- Conduct a daily inspection to ensure that secondary plastic covered emergency exits can be reached and used.
- Mark all exits from the work area and post directional arrows to them if they are not visible from all work areas.
- Be sure all emergency exits and exit routes are adequately lighted, even in the event of electrical failure.

Summary of Worker Responsibilities in the Event of Fire:

- Be sure you understand the written Fire Prevention Plan and Fire Emergency Plan *for each job* and *for each crew* you will work with.
- Be sure you know the system for alerting workers of a fire or other problem that may require evacuation of the work area.
- Know where a telephone is that can be used for notification of authorities in an emergency. Know how to make that notification.
- Know where local Fire Department and rescue Squad phone numbers are posted.
- Ensure that there is an assigned person outside at all times trained in emergency procedures. Someone should be trained in first aid, and in the treatment of heat stress.
- Know where all emergency exits are located, both primary and secondary ones.

The Most Important Emergency Fire Rule:

In case of fire, the fire hazard becomes more immediate than the asbestos hazard and workers may break down the plastic and other barriers to escape from the enclosures.

NON-ASBESTOS RESPIRATORY HAZARDS

There are various categories of respiratory hazards that might be encountered on an asbestos project that may require the use of respirators other than HEPA negative pressure type.

Respiratory hazards are generally categorized as follows:

- Oxygen deficiency.
- Gas and vapor contaminants.
- Particulate contaminants (aerosols including dust, fog, fume, mist, smoke and spray).
- Combinations of gas, vapor and particulate contaminants.

The type of respirator to use depends on the category and concentration of the contaminant.

- The basic respiratory hazards listed above are classified according to the expected biological effects of the contaminants.
- Respirators are designed and selected on the basis of chemical and physical properties of the air contaminants.
- Respirators designed for use in protecting an individual against asbestos fibers are not necessarily good for protecting an individual against other types of respiratory hazards (the reverse is also true).

Selecting respirators:

- OSHA requires stringent procedures for the proper selection of respirators.
- Workers also must be thoroughly trained in the selection, use, fit and limitations of respiratory equipment.
- No workers should ever use respiratory equipment or attempt to select such equipment without prior training and evaluation of the workplace.

CARBON MONOXIDE POISONING

Carbon monoxide (CO) poisoning is a major risk associated with the use of fossil-fueled equipment such as electrical generators, heaters and air compressors.

1. Carbon monoxide is:

- Colorless
- Odorless
- Tasteless

2. Carbon monoxide poisoning symptoms include:
 - Dizziness
 - Nausea
 - Headache
 - Drowsiness
 - Vomiting
 - Physical collapse into unconsciousness and coma prior to death
3. Carbon monoxide sources include:
 - Oil lubricated compressor
 - Internal combustion engine
 - Open flame and fire
 - Unvented gas fumes
 - Kerosene heaters
4. Motorized equipment exhaust - In some abatement situations, it may be necessary to use fossil-fueled equipment in or near the abatement site. Be aware that LP gas-powered equipment, when used indoors, has the potential to generate heavy carbon monoxide concentrations with little “combustion” odor such as would be the case with gasoline or diesel fueled equipment.
5. If such equipment is necessary, make sure that:
 - It has been adequately tuned up.
 - There are no excessive carbon monoxide concentrations in the exhaust gases.
 - Provide adequate ventilation.
 - Conduct continuous carbon monoxide monitoring.
 - If available, use catalytic combustors designed to eliminate carbon monoxide from the exhaust.

CONFINED SPACES

Definition

OSHA has defined confined spaces as having the following characteristics:

- Large enough and so configured that a person can enter.
- Limited or restricted means for entry or exit.
- Not designed for continuous human occupancy.

Examples of Confined Spaces

- Railroad tank cars.
- Underground sewers, walkways and tunnels.

- Processing tanks (either top or side entry).
- Manholes.
- Above or below ground pits with limited access.
- Steam tunnels or crawl spaces.

OSHA defines a **Permit Required Confined Space** as a confined space with any one of the following characteristics:

- Contains or has the potential to contain a hazardous atmosphere.
- Contains a material with the potential for engulfing an entrant.
- Has an internal configuration such that an entrant could become trapped or asphyxiated by inwardly converging walls or by a floor that slopes downward and tapers to a smaller cross-section.
- Contains any other recognized serious safety or health hazard.

Entering Confined Spaces

Asbestos workers may find it necessary to enter such areas to conduct inspection, maintenance or abatement activities.

Before entering such areas, it is vitally important to establish if the space is a permit required space. If so, entry can only be performed by properly trained and equipped personnel and an attendant with non-entry rescue equipment must be present.

Confined Space Rescue Attempts: WARNING!!

Do not enter a confined space to attempt to rescue unless you are properly trained and outfitted with the correct protective equipment (including your own safety retrieval harness, with someone tending your line).

Respirators are limited in their ability to protect the wearer from atmospheric hazards. For example, a negative pressure or powered air purifying respirator will not protect you against insufficient oxygen or a host of other contaminants for which the respirator was not designed. Therefore, only self-contained breathing apparatus can be worn during confined space rescues.

60% of confined space deaths are among would-be rescuers. Don't become a statistic!

Rules for Confined space Work

- Pre-plan for confined space work.
- Read and comply with OSHA 1910.146 "Permit Required Confined Spaces"

- Obtain the necessary training and equipment.

NOISE CONSIDERATIONS

Noise and Hearing Facts

1. Excessive noise destroys the ability to hear and puts stress on other parts of the body.
2. There is no cure for most of the effects of excessive noise.
3. Causes of noise damage:
 - Damage depends mainly on how loud the noise is and how long the person is exposed to it without proper protection.
 - High-pitched noise is much more dangerous than low-pitched noise.

Asbestos workers and Noise Exposure

Asbestos workers can become exposed to very high noise levels on the job, from:

- Background noises.
- Loud processes going on in the area of the project.
- Passage of products such as high-pressure steam through pipelines on which they are working.
- Use of heavy equipment during abatement.

Controlling Noise Exposure

Noise exposure can be controlled. No matter what the noise problems may be in a particular work place, technology exists to adequately reduce the hazard.

It may be possible to:

- Use quieter work processes.
- Alter or enclose equipment to reduce the noise at its source.
- Use sound-absorbing materials to prevent the spread of noise by isolating the source.
- Use proper personal hearing protective devices.

Personal Hearing Protection Devices

Perhaps the most appropriate means of protecting workers from high noise levels is the use of protective hearing devices. Devices come in many different shapes and styles, in two categories:

1. Occluding earphones, which surround the ear and prevent noise from hitting the outer ear.
2. Foam, soft plastic or rubber outer ear inserts. These are generally shaped or molded to be inserted into the ear canal. These devices can lower the noise level to which an individual is exposed by 15 to 20 decibels or more.

Responsibility

The responsibility for protecting workers' hearing lies with both the worker and the employer.

- If hearing protection is available to you, use it.
- If you are working in an area where the noise level seems excessive to you, request hearing protection from your employer.

Monitoring

Your company must monitor noise in the workplace and is required by OSHA to respond to all worker complaints.

MEDICAL EMERGENCIES

Regardless of precautions and reasonable care, medical emergencies can happen due to sickness or accident.

Your company must have established procedures to be followed in medical emergencies.

- Know your company's accident and safety manual.
- Ask for training for dealing with medical emergencies.
- Know where the first aid kits are and how to use them.
- Know where the nearest phone is to call for help. If not in a 911 area, know the phone number of emergency services.
- If possible, obtain first aid and CPR instructions.

Heat Related Disorders

It is important for the employer to provide training in recognition and awareness of the symptoms and effects of heat-related illnesses. It is also imperative to emphasize the importance of drinking water and maintaining proper electrolyte

balance when working in hot environments or while wearing protective clothing. The use of protective clothing and respirators greatly reduces the ability to properly regulate body temperature. As a consequence, when any full-body protection is used, heat stress is a potential hazard that must be addressed.

The four types of heat related disorders are 1) heat rash, 2) heat cramps, 3) heat exhaustion, and 4) heat stroke. Of these disorders, heat exhaustion and heat stroke are serious conditions that require immediate attention.

It should be noted that certain prescription and over the counter drugs as well as alcohol use can cause individuals to be more prone to heat exhaustion and heat stroke. When working in hot environments, these factors must be considered.

Heat Exhaustion

The symptoms of heat exhaustion may include any or all of the following:

- Fatigue
- Weakness
- Profuse sweating
- Normal body temperature
- Pale, clammy skin
- Headache
- Cramps
- Vomiting
- Fainting

Treatment for heat exhaustion includes:

- Remove worker from hot environment.
- Have worker lie down and elevate feet.
- Apply cool wet clothes or water.
- Loosen or remove clothing.
- Provide fluid replacement (electrolyte drinks if available) unless vomiting.

Prevention of heat exhaustion can be enhanced by:

- Providing frequent breaks away from hot area.
- Increase fluid intake.
- Allow for acclimatization to heat over a period of days.
- Provide external cooling systems (vortex tubes, ice vests).

While not usually a medical emergency, heat exhaustion should be recognized and treated promptly or it will lead to heat stroke.

Heat Stroke

Heat stroke is a life threatening disorder and requires immediate medical attention. The field treatment tips provided below must only be considered emergency first aid to be provided until medical help arrives. The first action When encountering an individual who appears to be suffering from heat stroke should be to call emergency medical services!

Symptoms of heat stroke include any or all of the following:

- Dizziness
- Nausea
- Severe headache
- Hot, dry, flushed skin
- Confusion
- Collapse
- Delirium
- Coma

Treatment for victims of heat stroke includes:

- Call for an ambulance.
- Remove worker from hot area.
- Remove clothing.
- Have worker lay down.
- Cool the body with shower or wet cloths.
- Do not give stimulants.
- Do not give fluids by mouth.

HAZARD COMMUNICATION/RIGHT TO KNOW

If chemical hazards are introduced to the workplace, the employer must have a written hazard communication program to inform employees of these hazards. Hazardous materials may be present on asbestos abatement sites for a number of reasons. Examples of potentially hazardous materials include spray adhesives, surfactants, encapsulants, paints and coatings, mastic removers, solvents and cleaning agents.

Hazard Communication Plan Elements

- Comprehensive written program
- Labeling of hazardous materials in the workplace
- Availability of Material Safety Data Sheets (MSDS)
- Employee training

Employers are required to inform affected workers about hazardous chemicals they may be exposed to through:

1. A written Hazard Communication Program which must include:
 - Plans to meet the criteria of the standard relating to the labeling, material safety data sheets, and employee training.
 - A list of hazardous chemicals/materials.
 - The methods to be used to inform employees and outside contractors of hazards of non-routine tasks.
 - The hazards associated with chemicals contained in unlabeled pipes or vessels in the work area, as well as hazardous materials released while using a product.
 - The methods to be used to inform outside contractors who may work on the premises of the hazards to their employees.
2. Material Safety Data Sheets.
 - All chemicals used in the work place must have material safety data sheets available at the work site, which must include all health hazard exposures, as well as physical hazards and emergency procedures.
 - All material safety data sheets must be accessible to all employees during any working time, which includes all three shifts, where applicable.
3. Labels.
 - All containers in the work place must be labeled, marked, or tagged with the identity of the hazardous material contained and the appropriate hazard warnings, and the name and address of a responsible party.
 - An exception from labeling is given for containers used by a single individual which hold only sufficient product for use during one shift.
4. Training for employees exposed to any hazardous chemicals in their work place must include:
 - The requirements of the Federal Hazard Communication Standard and the New York State Right-to-Know Law.
 - Information regarding the operations involving hazardous chemicals.
 - The location and accessibility of the Material Safety Data Sheets.

- The location and content of the written Hazard Communication Program.
- The methods and observations that may be used to detect hazardous chemicals.
- The physical and health hazards of the chemicals themselves.
- How employees can obtain, interpret, and use the information in the written hazard communication program.

Information on possible hazardous exposures should be reviewed with employees before the exposure occurs so proper precautions can be taken. Material Safety Data Sheets must be made available by manufacturers, suppliers of products and from owners of facilities where hazardous materials are handled in the removal area. Contractors who work in facilities where hazardous chemicals are present may fall under the umbrella of the Hazard Communication Program of the facility owner even if the contractor does not use any hazardous materials directly, so long as these materials are present in the immediate area of the abatement project.

WORKING WITH CHEMICALS

HOW TO USE THE RIGHT TO KNOW LAW

Where can I get information on the chemicals I use at work?

Check your company bulletin board. If your worksite is covered by the Right To Know Law there should be a notice that says you have a right to information on the chemicals you could be exposed to at work. This notice can come in many shapes and sizes, so look carefully. It will often identify the person or office you should contact. If no contact person is listed ask your supervisor how to go about requesting chemical information.

What do I ask for?

Once the contact person has been identified, you should ask him or her for information on any chemical or mixture that concerns you. Try to be as specific as you can in identifying the chemical. It is a good idea to submit your request in writing and for you or the contact person to note the date and time when a request is made. Also, keep a dated copy of the request for yourself. Your employer should be able to provide you with information within three workdays.

What information can I expect to receive?

You will usually be given a Material Safety data Sheet (MSDS). The law lists several types of information that should be provided to you, most are found on MSDSs. They are:

- Generic or chemical names of the substances
- Trade name of the substance
- Levels at which exposure to the substance may be hazardous, if known
- Short-term and long-term effects of exposure at hazardous levels
- Symptoms of such effects
- Flammability, explosion potential and chemical reactivity of the substance
- Appropriate emergency treatment for excess exposure
- Proper conditions for safe use and exposure to the substance
- Procedures for cleanup of leaks and spills

MSDSs can be difficult to understand. Sometimes important information may be missing or written in confusing technical language. Your employer has an obligation to contact the manufacturer for any missing information and to explain any terms or language that you don't understand. The New York State Department of Health can help. If your employer has difficulty getting information from a manufacturer the Health Department can help obtain the information. The Department can also provide booklets for employees that explain the Right To Know law and some of the language used in MSDSs.

For some products, like over-the-counter drugs preparation of a MSDSs may not be required by federal law and chemical information may not be available in the form of an MSDS. However, if you work with these materials you still have a right to the categories of information listed above. In cases like these what your employer gives you may not look like an MSDS but it should contain the same information.

Your employer cannot claim that a substance is not toxic or that no information exists on a substance without confirmation from the manufacturer, the New York State Department of Health, the Environmental Protection Agency and the National Institute for Occupational Safety and Health.

What if my employer doesn't respond to my request?

If you do not get the information within three workdays you have the right to refuse to work with that substance until the information is provided. Your employer could assign you to different duties. The law says that your employer cannot discriminate against you for exercising your rights. If you feel you have been penalized contact the New York State Labor Department or the New York State Attorney General at the following addresses:

New York State Department of Labor
OSH Intergovernmental Relations
State Office Building Campus
Bldg. 12 Room 579
Albany, NY 12240
518-457-5508

New York State Department of Law
Environmental Protection Board
120 Broadway
26th Floor
New York, NY 10271
212-341-2706

Can someone else make a request for me?

The right to know law says that you or your representative can request information on the materials you may be exposed to at work. Your union steward, members of your family, your doctor or anyone else you select could ask for information on your behalf.

What if my work place is covered by the Federal OSHA Hazard Communication Standard instead of the NYS Right To Know Law?

Everyone in New York State is covered by one law or the other. If your workplace is covered by the Hazard Communication Standard, your employer should have MSDSs for all of the materials found in your workplace and make them available to you during normal work hours.

What if I need chemical information and my employer doesn't have it?

In responding to a problem, you or your employer can contact the Health department for chemical information. Health Department staff will provide any available information over the telephone and can usually send copies the same day. Some requests will require research and more time to prepare a response. If you call, have as much information on the substance as you can find, including the name of the substance, the name and address of the manufacturer and if available, the Chemical Abstracts Service (CAS) number. The Health Department can be reached at the following address:

New York State Department of Health
Bureau of Toxic Substance Assessment
547 River Street
Troy New York, 12180
(518)-402-7810

TABLE 11-1 GENERAL SITE SAFETY RULES

ACCIDENTS OR INJURIES, no matter how minor, must be reported to your supervisor for immediate treatment or first aid to prevent infection or complication.

JOB CLEANLINESS. Housekeeping shall be practiced on all projects. Excess material and supplies not needed on present operations shall be properly stored until needed.

PERSONAL PROTECTIVE EQUIPMENT shall be provided and shall be used by employees where potential hazards exist. This includes lifelines where a danger of falling exists, respiratory equipment in a dangerous atmosphere, safety glasses, goggles, or face shields on all operations where there is exposure to flying objects or anything injurious to the eyes. Employees will also be provided with hard hats, hearing protection, gloves, boots, and disposable coveralls as required by project assignment. The employee is responsible for the proper use and care of all such equipment while on projects.

FOOT PROTECTION. Where required by project conditions, safety shoes or boots are to be worn. Check with supervisor prior to assignment to determine proper foot protection requirement for the project.

BE ALERT when handling rough edges or abrasive materials. When a worker's hands may be exposed to lacerations, punctures, extreme cold, burns, or chemicals, special hand protection may be designated by the project supervisor.

CLOTHING shall be appropriate to the duties being performed and shall not include torn or loose articles.

HAND TOOLS shall not be used for any other purpose than that intended. Hand tools provided by either the employee or the employer that are damaged or worn shall be promptly repaired or replaced.

POWER TOOLS shall be operated only by authorized personnel, in accordance with manufacturers' instructions, and if electrical, shall be grounded. Portable power tools shall be used with GFCI circuits only. The exhaust of power tools must be filtered through a HEPA filter.

ELECTRICAL WIRES shall be considered "live" until checked and locked out. Keep a safe distance from electrical equipment such as transformers and switchgear.

MACHINE GUARDS shall be kept in place while machinery is in operation. Tampering with machine guards is prohibited.

COMPRESSED GAS CYLINDERS shall be chained or otherwise secured in an upright position, and shall be placed in cylinder carts whenever being transported to different locations on a project. Empty cylinders shall be removed promptly from the project. Flammable gases and oxygen/air cylinders shall be stored at least 20 feet apart from each other as per OSHA's occupational safety and health standards 29CFR1910.253(b)(2)(ii)

COMPRESSED GASES are not to be used for dusting off clothes or equipment.
NEVER POINT AN AIR HOSE AT ANYONE!

SOURCES OF IGNITION shall be prohibited from areas where flammable liquids, gases or explosives are stored or issued, and appropriate warning signs shall be posted at these locations. "NO SMOKING" rules must be observed in posted areas.

ALCOHOL AND NONPRESCRIBED DRUGS – possession or use during working hours is strictly forbidden.

FIRE EXTINGUISHERS – Tampering with or unauthorized removal of fire extinguishers from assigned locations is prohibited. Partially used or empty fire extinguishers shall be reported to project supervisor or appropriate site representatives. Know the location and use of fire extinguishing equipment at each assigned project and procedures to give fire alarm.

FLAMMABLE LIQUIDS shall be contained in approved metal safety cans, and/or appropriate shipping cartons.

EQUIPMENT OPERATION – Employees shall not operate any machinery, equipment or tool unless instructed in the proper use and details of its operation.

BE AWARE of work going on around you. Keep clear of suspended loads and traffic areas. Work with care and good judgment at all times.

HORSEPLAY OR PRACTICAL JOKES shall not be permitted or tolerated on jobsites before, during and after work hours.

AVOID SHORTCUTS – Use designated walkways, ramps, stairs, ladders, etc.

SAFETY PRECAUTIONS – Familiarize yourself with required safety precautions and procedures specific to each jobsite before beginning work.

SECTION 12

PRINCIPLES AND PRACTICES OF ASBESTOS AIR SAMPLING

INTRODUCTION

Air sampling and analysis is critical in determining exposure to airborne asbestos fibers for both the worker and the unprotected public in the area surrounding an abatement project. Due to the microscopic size of asbestos fibers, air sampling is the only definitive way of determining these exposures as well as to determine if an abatement site can be released for re-occupation. Collection of reliable data requires a thorough knowledge of the techniques and equipment used in air sampling. This section presents a basic introduction to the topic.

TYPES OF SAMPLING

1. **Personal Air Sampling: Purpose:** OSHA Compliance/worker protection

Air samples are collected in the breathing zone of the worker using a portable, battery operated sampling pump. Sampling requirements include both full shift, 8-hour Time Weighted Average (TWA) samples, and 30 minute, Excursion Limit (EL) samples. Personal air samples are also referred to as “breathing zone samples”.

2. **Area Air Sampling: Purpose:** Code Rule 56 and/or AHERA compliance

Area air samples are collected in pre-selected locations using either low volume battery operated or high volume electric sampling pumps. New York State Code Rule 56 specifies four distinct categories of asbestos abatement project area air monitoring:

- Background
- Pre-Abatement
- Daily (work-in-progress)
- Final Clearance (aggressive)

In addition, the United States Environmental Protection Agency (USEPA) AHERA Standard requires clearance air sampling for school abatement projects.

PERSONAL SAMPLING

Personal air sampling is performed to comply with OSHA requirements for monitoring and documenting workplace exposures to airborne hazardous substances. In addition to fulfilling the OSHA requirements, these samples serve the following functions:

- To determine the level of respiratory protection needed.
- To determine the quality of work practices.
- In order to provide sufficient data for a Negative Exposure Assessment.

General Considerations

To perform air sampling in the breathing zone of the worker, we cannot use stationary (120 VAC) sampling equipment. Asbestos abatement workers are very mobile and do not have a permanent workstation. Therefore, portable battery powered sampling pumps are used.

The portable pump is placed on the worker, typically suspended from a waste belt made from duct tape. Positioning the pump at the back minimizes the interference of the pump with the work being performed. The air tubing is strung from the pump over the shoulder of the worker and is securely taped there. The air sample cassette must be placed within the worker's breathing zone (within a 1 foot hemisphere centered around the employees mouth), typically at the shoulder or lapel area. The cassette should be angled downward to prevent water sprays and/or debris from falling directly into the filter.

The exposures of representative workers assigned to each distinct task must be evaluated. For example, if there are two people scraping, 2 people bagging and 2 people in the waste decon station, a minimum of 3 personal full shift (TWA) samples must be run and 3 EL samples must be run.

Personal air sampling has to be performed initially to determine worker exposures at each site. If measured levels are statistically reliable and consistently demonstrated to be below the PEL of 0.1 fiber per cubic centimeter (f/cc) or if a Negative Exposure Assessment has been obtained, the personal air sampling can be discontinued for the employees for whom the air sampling was representative.

Personal air sampling is performed for the duration of the shift and is calculated as an eight hour Time Weighted Average (TWA). Excursion samples (EL - 30 min.) are performed during peak exposure periods. The fiber concentrations in the work area will depend, in large degree, on the type of work practices being employed. It is obvious that the fiber concentrations will not stay constant during the shift. If one cassette is used for the duration of the sampling, no special calculation is necessary because all of the fibers will be collected on the same filter and fiber concentrations will be averaged by the nature of the sampling method. In some situations, however, the fiber and dust concentrations will be too high to permit continuous air sampling on the one filter for the full shift.

In this case, the filter will become overloaded with fibers and/or dust and will become unreadable. When the expected fiber or dust levels are high, the sampling period can be split into shorter periods, with a new cassette being used for each period. In any case, the sampling must continue throughout the full work shift.

The TWA for this type of sampling will be calculated in the following manner:

<u>Sequential Samples</u>	<u>Fibers/cc</u>	<u>Hours of Sampling</u>
P-1	0.1	2
P-2	0.2	2
P-3	0.3	2
P-4	0.1	2
P-5	0.1	2

$$\text{TWA} = \frac{0.1 \times 2 + 0.2 \times 2 + 0.3 \times 2 + 0.1 \times 2 + 0.1 \times 2}{8} = 0.2 \text{ f/cc}$$

Note that in this case, the shift lasted ten hours; however, the average is based on an eight-hour exposure. The reason for this is that the PEL is established as a TWA over an eight-hour period. In other words, you cannot be exposed to the PEL for more than 8 hours per day. Exposure to 0.1 fibers/cc for more than 8 hours/day will result in exceeding the PEL.

Calibration of Air Pumps

OSHA recommends a flow rate of from 0.5 to 2.5 liters per minute (lpm) for personal air sampling. The calibration procedure for personal pumps is identical to the calibration of stationary high-volume pumps. The calibration should be repeated at the end of the sampling period and both the starting and ending flow rates should be recorded on the chain-of-custody form (data sheet).

Some pump models have built-in rotometers. These rotometers should be calibrated at least once a month as they are often subject to contamination and abuse under field conditions. It is good practice however, to use a precision rotometer for all daily pump calibrations even when the pump is equipped with a built-in rotometer. Pumps that are calibrated incorrectly will result in an inaccurate volume, thereby providing the worker (and employer) with incorrect estimates of the actual exposure. In most situations, incorrect information is worse than no information at all.

The Sampling Procedure

Personal air sampling, as per OSHA regulations, is the responsibility of the employer. In practice, the project air-sampling technician may be called upon to answer questions regarding the techniques of personal air sampling because the knowledge of contractor field personnel in this area may be limited.

Personal sampling must be started simultaneously with the start of exposure, typically when the worker enters the containment. The sampling is stopped when the exposure is discontinued (lunch or other breaks). If the pump is left running inside the containment, the resulting TWA as calculated from the results of sampling will be higher than the actual worker exposure, which may lead to unnecessary use of more expensive and cumbersome respiratory protection equipment.

When a worker takes a lunch break, or otherwise ceases to be exposed for a period of time, the pump is stopped and the time recorded on the chain-of-custody form. When the worker returns to the containment to resume work, the pump is re-started and this time is recorded on the chain-of-custody form. When the shift ends and the worker exits the containment, the pump is stopped and the final stop time and flow rate are recorded.

If the filter falls out of the holder before, during or after sampling, the sample is invalidated and must be replaced. The appropriate information should be recorded on the chain-of-custody form. Similarly, if the cassette comes apart during sampling, the sample must be voided. However, if the cassette itself falls off the tubing, but the filter remains intact and is not contaminated, the filter can be re-attached and sampling can be continued.

Pump Maintenance

Personal air sampling pumps operate on rechargeable batteries. Depending on the model, twelve to sixteen hours of charging time are necessary for the eight to ten hours of operation. The battery should always be fully charged before the start of sampling. If pumps are consistently run for less than 8 hours, some batteries may develop a "memory" and will not retain a charge adequate for more than the time it has routinely been run. To avoid this condition, periodically allow the pump to run until the battery has fully discharged. Some chargers are equipped with a discharge/recharge feature to perform this step automatically. Always follow the Manufacturer's recommendations for pump and battery maintenance.

The Analytical Method

The OSHA Recommended Method (ORM) for personal air sampling in asbestos abatement is the NIOSH 7400 Method, which is provided at the end of this section. The NIOSH method specifies Phase Contrast Microscopy (PCM). The advantages of PCM is that it is relative simple and low cost. The disadvantage is its lack of specificity. This means it will not distinguish between asbestos fibers and non-asbestos fibers, thus all fibers will be counted.

- **Summary of the PCM Analytical Method** - The mixed cellulose ester (MCE) filters are collapsed by acetone vapor. This makes the filter transparent, however, some fibers are transparent also. To enable the analyst to see the transparent fibers, Phase Contrast Microscopy is used. In short, PCM makes the transparent fibers visible because they have a different refractive index (they bend light differently) than the filter media. The magnification used for PCM is 400 X.
- **Definition of a fiber** - Regardless of the analytical methods used, a fiber is defined as a structure which is at least five microns (one millionth of a meter) long, and has a length to width aspect ratio of at least 3:1. Both of these criteria are based on the current knowledge of health effects of asbestos fibers. It is presently accepted that fibers less than 5 microns long do not exhibit significant health effects. The rationale for the length to width ratio limitation is the same.
- **Preparation Technique and Analysis of the Sample** - A glass slide with the collapsed filter on it is viewed under the phase contrast microscope. The microscope is equipped with a device called a Walton-Beckett reticule. This device limits the field in which the fibers will be counted. The reticule is an optical piece of glass with a 100mm diameter circle etched into the glass. The area of this circle represents a "field". After the fibers are counted in a specified number of fields, the total number of fibers on the filter can be calculated. The method requires counting 100 fields or 100 fibers, whichever comes first. A minimum of 20 fields must be counted. Dividing the resulting fiber count by the number of liters of air that was collected allows a determination of the concentration of fibers in the sampled air.
- **Transmission Electron Microscopy (TEM)** - TEM is the definitive method for analysis of air samples for airborne asbestos fibers. This method is mandated by the AHERA standard for final air sampling in schools. The advantages of this method include its higher sensitivity and specificity. Higher sensitivity is explained by the higher magnification achievable with electron microscopy (4000 X common for asbestos analysis) permitting thinner fibers to be seen as compared to PCM. The specificity of the method is explained by its coupling with X-ray diffraction (XRD). The crystalline structure of the mineral can be determined by using XRD. This structure will be not only specific for each type of asbestos, but will also be specific for the same types of asbestos coming from different mines. Therefore, a positive identification of asbestos structures is possible. The disadvantages of TEM are the longer time required for analysis (time for the filter dissolution alone is 24 to 32 hours) and the higher cost, resulting from the higher costs of equipment, labor and exhaustive quality control work. Concerns are being expressed that with market pressures and falling prices, the quality of analysis may be compromised.
- **Summary of the TEM procedure** - Filters to be analyzed are coated with a thin layer of platinum or graphite in a vaporizer, then dissolved in an acetone vapor and placed in the electron microscope and viewed. X-ray diffraction on selected structures is performed. The resulting diffraction pattern is analyzed.

Determination of airborne fiber concentration from the analytical results is identical to that of the PCM method.

- **Scanning Electron Microscopy (SEM)** - Scanning electron microscopy is more expensive and time-consuming than PCM, but less so than TEM.

Both TEM and SEM utilize electron microscopy. However, only SEM shows the surface of the sample, whereas TEM creates the image of the whole depth of the sample. As XRD is not used with SEM, this method in contrast to TEM, is not specific for asbestos fibers because it relies on the morphology (shape) of the fiber and does not provide information on the crystalline structure of the material. As a consequence, SEM is rarely used for asbestos analysis.

Choosing an Appropriate Method

Without specifically stating it, the State and Federal Government, as well as the Industrial Hygiene community, have tacitly agreed that Phase Contrast Microscopy provides an index number that can be used both for worker and public protection. Indeed, when counting all fibers, rather than just asbestos fibers, we seem to err on the side of overprotection, rather than under protection. This statement is supported by practical experience that shows that a site which had a satisfactory PCM result very seldom fails under side by side TEM sampling, while the reverse may happen quite often.

TEM analysis, however, is mandated under EPA (AHERA) regulations. Therefore, in addition to the New York State Department of Health ELAP accreditation, final air sampling in school projects has to be performed by TEM. In New York State, the project cannot be cleared by TEM alone unless the pre-air and dailys were also analyzed by TEM methodology. Therefore, because New York State requires consistency of methodology, school projects typically have to be sampled by both PCM and TEM methodology on a side-by-side basis, with the TEM samples usually held pending satisfactory clearance by PCM analysis.

TEM analysis may also be mandated by contract specifications for any project if the architect or project designer decides it is necessary or desirable. For example, TEM sampling is frequently specified for health care facilities, pharmaceutical manufacturing plants and large office complexes undergoing abatement projects.

The Analytical Laboratory

OSHA requires that the analytical laboratory successfully participate in a national quality assurance program. For work performed in New York State, the analytical laboratory selected must be accredited/certified by the American Industrial Hygiene Association (AIHA) and the New York State Department of Health Environmental Laboratory Approval Program (NYSDOH ELAP).

AREA AIR SAMPLING

Area air sampling is conducted to comply with New York State Code Rule 56 requirements and/or AHERA requirements. Four types of air sampling are detailed in Code Rule 56 and are described below. Area air samples, except for Background and Clearance air samples, shall be collected and air samples run for each entire work shift. Area air samples must be collected with a minimum flow rate capacity of two (2) liters per minute (lpm) and a maximum flow rate consistent with the applicable accepted air sampling and analysis methodology. The flow rate for each air sample shall be pre-calibrated and post-calibrated at the beginning and end of each air sample collection. The calibrations shall be recorded. Primary and secondary calibration devices shall be calibrated as per NYS DOH ELAP requirements. The air sampling technician shall be on-site to observe and maintain air sampling equipment for the duration of air samples collection.

Background Samples

Background samples are collected before any other work relating to the abatement project begins. The purpose of background sampling is to determine the background or ambient level of airborne fibers prior to the start of any work which might artificially increase these levels. The background samples will be used later to determine if the airborne fiber concentrations have changed as a result of pre-abatement site prep work or by the abatement work itself. It is obvious that it will be impossible to determine such changes without results of the analysis of these samples taken prior to the start of other field activities. Background samples are collected both inside and outside the prospective work area.

Work Area Preparation Samples

Work Area Preparation (Prep) air samples are collected during abatement site prep work but prior to the start of actual abatement activities. When required, "Work Area Prep" samples are collected outside the prospective work area and must be collected during each shift, for the entire workshift, throughout the prep phase of the project.

Asbestos Handling Air Samples

Air samples collected while the abatement project is in progress are referred to by several names including "work in progress samples (WIPs), environmentals, dailys, etc. This type of air monitoring is performed every day while abatement activities occur.

When required, Asbestos Handling, or WIP, air samples are collected outside the work area only, including the clean room of the decontamination facility and at each negative air exhaust or 1 sample collected at the terminating point of a bank of up to a max of five negative air exhausts. The purpose of this air monitoring is to document the integrity of the containment barriers and the proper functioning of the negative air machines.

Should the barriers become damaged, or the pressure differential between the work area and adjacent areas disappear, a possibility is created for the airborne fibers within the containment to escape and contaminate the surroundings. A comparison is

made between these daily samples and samples taken outside the work area prior to the start of abatement (backgrounds).

If an elevated fiber concentration is detected, one of the possible conclusions is that the contamination of the outside area is due to faulty abatement practices. When elevated airborne fiber levels are detected, the work must stop and the reasons for the elevated fiber levels shall be determined. The area outside the work area must be cleaned prior to the restart of abatement practices.

It should be noted that many activities could result in elevated fiber levels including vacuuming of carpets, cutting wood, re-insulation work involving fiberglass and other similar activities. These possibilities must also be investigated. If it is believed that the source of the elevated fiber levels is not associated with the abatement project, transmission electron microscopy (TEM) analysis may be performed to verify that the fibers are non-asbestos.

Post Abatement (Final Clearance) Sampling

Air samples collected at the conclusion of the abatement project are referred to as final or clearance samples. Final samples are collected inside and outside the abatement containment in the identical positions as the original background samples. The purpose of these samples is to determine if the abatement project work area satisfies the *New York State clearance criteria* of <0.01F/CC or the established background, whichever is greater. If the abatement project is a school, the *AHERA clearance criteria* of less than or equal to 70 structures/mm² also applies.

If the final air samples are below the appropriate clearance criteria, the area can be released to the building occupants following removal of the containment and all asbestos waste.

Clearance samples must be collected using *aggressive air sampling techniques*. This means that the air is agitated prior to and during the air sampling process with air moving devices such as a leaf blower and fans.

Aggressive Sampling Techniques

Aggressive sampling shall be performed in the following manner:

Pre-sampling Agitation: Before starting the sampling pumps, direct the exhaust of forced air equipment against all walls, ceilings, floors, ledges and other surfaces. Continue for at least five minutes per 1000 square feet of floor space within the enclosure.

On-going Agitation: Use a 20-inch fan placed in the center of each room. Use one fan per 10,000 cubic feet of space within the enclosure. Operate the fan(s) on slow speed and point towards the ceiling until the sampling is finished. During clearance air sampling, the negative air equipment must be operated at a rate of *two* air changes per hour.

Determining the Number of Samples to Be Collected

The following table summarizes the types of air sampling to be performed for each size of abatement project and the minimum number of samples, which must be collected according to NYS CRR 56.

ASBESTOS PROJECT AIR SAMPLING REQUIREMENTS

Air Sampling Requirements by Asbestos Project & Regulated Abatement Work Area Size	Phase I B Background Air Sampling	Phase II A Work Area Preparation Air Sampling	Phase II B Asbestos Handling Air Sampling	Phase II C Final Cleaning & Clearance Air Sampling
LARGE ASBESTOS PROJECT OR LARGE SIZE REGULATED ABATEMENT WORK AREA	Required	Required ⁽⁵⁾	Required	Required ⁽⁶⁾
Minimum Samples Required ⁽¹⁾	5 Inside Regulated Abatement Work Area & 5 Outside Regulated Abatement Work Area in Building/Structure ⁽²⁾	1 per decontamination entrance/exit 1 per negative air exhaust or per bank of 5 exhausts 2 at critical barriers 1 outside the building/structure		5 Inside Regulated Abatement Work Area ⁽⁷⁾ & 5 Outside Regulated Abatement Work Area in Building/Structure ⁽²⁾
SMALL ASBESTOS PROJECT OR SMALL SIZE REGULATED ABATEMENT WORK AREA	Required	Not Required		Required ⁽⁶⁾
Minimum Samples Required ⁽¹⁾	3 Inside Regulated Abatement Work Area & 3 Outside Regulated Abatement Work Area in Building/Structure ⁽²⁾	0		3 Inside Regulated Abatement Work Area & 3 Outside Regulated Abatement Work Area in Building/Structure ⁽²⁾
MINOR ASBESTOS PROJECT OR MINOR SIZE REGULATED ABATEMENT WORK AREA	Not Required	Not Required		Required ^(3, 4)
Minimum Samples Required ⁽¹⁾	0	0		1 Inside Regulated Abatement Work Area & 1 Outside Regulated Abatement Work Area

Notes:

- (1) For sample location and total number required, see Subparts 56-6 through 56-9.
- (2) 1 sample outside the building/structure if entire building/structure is regulated abatement work area.
- (3) Required on glove bag failure or loss of integrity, or tent failure or loss of integrity.
- (4) Required for an Incidental Disturbance Project or if minor size regulated abatement work area is part of small or large asbestos project.
- (5) Required for all OSHA Class I and Class II Friable ACM asbestos projects.
- (6) During IIC final cleaning stage, air sampling as per Phase IIB is required.
- (7) One additional inside sample shall be required for every 5,000 sq. ft. above 25,000 sq. ft. of floor space within the regulated abatement work area.

The table above summarizes the requirements of State of New York regulations. You can collect additional samples if you think it is necessary, but you cannot collect any less samples than specified in the table.

For a minor project, no area sampling is mandated, except if there is a breach or loss of integrity in the glovebag or tent, or upon an incidental disturbance or if the minor project is part of a small or large project. However, if you do make a decision to perform area air sampling on a minor project, make sure you collect background samples. Otherwise you will have no baseline for the results of final air sampling.

AREA AIR SAMPLING TECHNIQUES

Equipment for Area Air Sampling

The following equipment is necessary for conducting area air sampling in support of abatement projects:

- High volume stationary pumps, associated flexible tubing and telescopic stands
- A calibrated rotometer
- Fans, leaf blower
- Power cords & GFCI
- 25 mm air sampling cassettes
 - 0.8 um Mixed Cellulose Ester Filter (MCEF) for PCM analysis
 - 0.45 um MCEF or 0.45 um Polycarbonate for TEM analysis

High Volume Sampling Pumps - High volume pumps are available from a variety of manufacturers and are very similar in design. The basic parts of the pump are the electrical motor (120VAC) and the vacuum pump mounted on the rotor of the motor. The vacuum pump is equipped with a regulating valve, a vacuum gauge (manometer) and a nipple for connecting the sample tubing. This assembly may also include a critical orifice (described below).

The pump is usually placed in a protective case, which is used for pump transportation, prevents mechanical and water damage to the pump, and can in some designs be used for mounting the telescopic stand. However, the stand must always be separate from the pump to prevent vibration of the air cassette.

Some pump models include multiple vacuum pumps mounted on one electric motor. Lengths of tubing are then used to provide for air sampling in appropriate locations. This version of air sampling equipment lacks the flexibility necessary for most typical asbestos abatement projects.

FIGURE 12-1
Proper Sampling Technique



FIGURE 12-2
Air Sampling Cassette

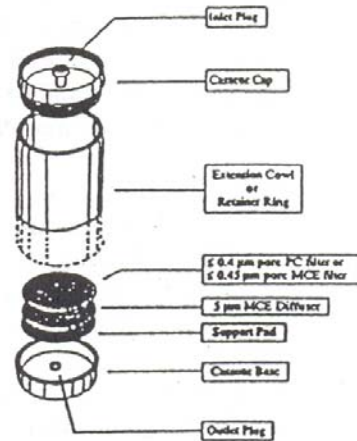

Critical Orifices

A critical orifice is a metal plug with a carefully machined hole in it. The principle of the critical orifice is that when air pressure downstream of the orifice falls below 53% of the air pressure upstream from the orifice, the air flowing through the critical orifice reaches the speed of sound, which it cannot exceed. Thus, as long as the vacuum pump maintains the air pressure downstream from the orifice below 53% of the upstream pressure, the flow rate through the orifice will be constant. The orifices can be manufactured and pre-calibrated to deliver a specific flow rate of 10 lpm, for example. Critical orifices have to be periodically calibrated and cleaned, because of dust accumulation in the orifices, which changes the effective diameter and consequently, the flow rate. The primary advantage of the critical orifice is the fact that the calibration of the pump will not vary during sampling (however, pump calibrations must still be documented before and after sampling).

Rotometers

A rotometer is a device for accurately measuring flow rate. The flow rate is the rate at which the pump is adjusted to draw air through the filter. This rate is usually expressed in liters per minute (l pm).

The body of the rotometer is often made of a block of clear plastic. Some are constructed with a glass tube. The diameter of the channel increases from the bottom to the top.

Inside the channel, a bore or float is placed. When air flows through the channel, it raises the bore to a level that is proportional to the volume of air flowing through the channel. The higher the flow rate, the higher the bore will be suspended in the channel. The rotometer is graduated in liters per minute or in low flow rotometers, in cubic centimeters per minute (cc/minute). The readings provided by a rotometer will change over time as a result of wear and accumulation of dust on the channel walls and bore. This makes it necessary to periodically calibrate the rotometer against a primary standard.

A primary standard flow meter is a glass burette or electronic calibrator. These devices use a large diameter channel and a soap bubble film instead of a metal, glass or plastic bore. A stopwatch is used in the glass burette system to measure the time necessary for the soap film to travel from a zero mark to a one-liter mark. The actual flow rate measured in liters per minute can then be calculated.

Calibration through the range of gradations on the rotometer is desirable, with a minimum of 5 rates being adequate, for example 2, 4, 6, 8 and 10 liters per minute.

Electronic calibrators also use a soap film and electronically time the flow with the aid of an infrared detector at the zero and end points of the channel.

Rotometers should be calibrated against primary standards on a monthly basis, quarterly at minimum. These calibrations should be documented.

Air Sampling Cassettes

Two types of filter material are used for asbestos air sampling. For PCM analysis, MCEF cassettes are used. For TEM analysis MCEF or Polycarbonate may be used, however, the pore size is smaller than for PCM analysis. The smaller pore size allows these filters to capture fibers of a smaller diameter, which cannot be seen under PCM analysis. The cassette body is identical in all cases.

Each cassette must be labeled with a minimum of a sample ID and date.

Extension Cords and Power Strips

Providing sources of electrical power on an asbestos abatement project is traditionally the responsibility of the contractor. However, the person performing air sampling will need adequate amounts of extension cords and power strips to set up the required number of sampling pumps in all the selected locations. The length and number of cords will be determined based on the size of the area to be covered and the availability of power source(s). It is important to assure that there is an adequate power supply prior to starting pumps. To determine if the power source is sufficient for the number of pumps needed, the following formula can be used:

AMPS X VOLTS = WATTS. For example, a 15-amp circuit at 120 volts will provide a maximum of 1800 watts (15 X 120 = 1800). The power requirements (in watts) of each

sampling pump should be found on the motor nameplate.

Extension cord use should also be considered in power calculations. Use only cords rated to carry the load anticipated and be aware that long lengths of cord and numerous connections will provide some resistance to current flow, reducing the maximum useable power at the end point. All circuits must be protected by GFCIs at the power source. OSHA regulations stipulate that extension cords not exceed two hundred (200') feet in length.

SELECTING AIR SAMPLING LOCATIONS

The locations for project area air samples are selected at the time of background and pre-abatement air sampling. Subsequently, air sampling during abatement and final clearance is performed in the same locations as the pre-abatement and background sampling.

The locations for sampling inside the future work area should be selected so that there is no restriction or obstruction of the airflow at the sampling point. The samplers should not be placed in corners or near walls. Within these constraints, the samplers should be placed at random in the work area. If the work area contains the number of rooms equivalent to the required number of samples, collect a sample in each room. When the number of rooms is greater than the required number of samples, a representative sample of rooms should be selected.

When selecting the locations outside the work area, one sampler should be placed at the entrance to the decontamination unit, one next to (at a maximum of 10 feet) the exhaust of each negative air machine, and 1 for a bank of up to five machines max and the rest equally spaced near the critical barriers. In doing so, all locations where the possibility of airflow from the containment out will be monitored.

AIR SAMPLING PROCEDURE

- Select the air sampling locations as described above.
- Determine power requirements and availability.
- Set up samplers.
- Label cassettes.
- Calibrate each sampler with the cassette in-line; adjusting the flow is necessary to obtain the desired flow rate.
- Remove the end cap of the cassette and begin sample collection.
- Fill out the chain of custody form (data sheet) by recording all data pertinent to the project, sample numbers, flow rates, time that the samplers were turned on, and the name of the individual conducting the sampling.

- Perform sampling for the time determined to be adequate to collect the desired volume of air (***daily air samples must be full shift in New York State***).
- Repeat the calibration procedure (do not adjust the flow rate at this time).
- Turn sampler off.
- Record the end flow rate and time off.
- Calculate the amount of time the pump was on in minutes and record it on the chain-of-custody form.
- Calculate the volume of air sampled and record it on the chain-of-custody form.
- Sign and date the form.

QUALIFICATIONS OF PERSONNEL PERFORMING AREA AIR SAMPLING

In New York State, the person performing project air sampling must hold a valid Air Sampling Technician license (Restricted II), since each individual must hold a valid license in the class for which the work is being performed. A project monitor would, therefore, be required to also hold a license as an air-sampling technician to conduct project air sampling. It should be noted that personal air sampling, since it is performed to comply with OSHA requirements, does not require a NYS air sampling technician license, but must be performed by a "competent person".

Formula: various

M.W.: various

Fibers
Method: 7400
Issued: 2/15/84
Revision #3 5/15/89

OSHA: 0.2 asbestos fiber (25 μ m long) /cc:
1 asbestos fiber/cc 30-minute excursion [1]

MSHA: 2 asbestos fibers (>5 μ m long) /cc [2]

NIOSH: carcinogen; control to lowest level possible [3]; 3 glass fibers (>4 μ m x<3.5 μ m /cc[4]

ACGIN: 0.2 crocidolite; 0.5 amosite; 2 chrysotile and other asbestor, fibers/cc [5]

Properties: solid, fibrous

SYNONYMS: actinolite [CAS #13768-00-8] or ferroactinolite; cummingtonite-grunerite (amosite) crocidolite [CAS # 12001-28-4] or riebeckite; tremolite [CAS #14567-73-8]; amphibole asbestos; fibrous glass.

MEASUREMENT

SAMPLING

SAMPLER: FILTER

(0.45 to 1.2 μ m cellulose ester membrane, 25 mm diameter; conductive cowl on cassette).

FLOW RATE: 0.5 TO 16 L/min

VOL-MIN: 400 l @ 0.1 fiber/cc
VOL-MAX (step 4, sampling)
Adjust to give 100 to 1300 fibers/mm²

SHIPMENT: routine (pack to reduce shock)

SAMPLE STABILITY: stable

FIELD BLANKS: 10% of samples

ACCURACY

RANGE STUDIED: 80 to 100 fibers

BIAS: see EVALUATION OF METHOD

OVERALL PRECISION (S): 0.115 to 0.13 [7]

TECHNIQUE: LIGHT MICROSCOPY, PHASE CONTRAST

ANALYTE: fibers (manual count)

SAMPLING PREPARATION: acetone/triacetin "hot block" method [6]

COUNTING RULES: described in previous version of this method as A rules [1,7]

EQUIPMENT: 1. Positive phase-contrast microscope
2. Walton-Beckett graticule (100 μ m field of view) Type G-22
3. phase-shift test slide (HSE/NPL)

CALIBRATION: HSE/NPL TEST SLIDE

RANGE: 100 TO 1300 fibersmm² filter area

ESTIMATED LOD: 7-fibers/mm²-filter area

PRECISION: 0.10 TO 0.12 [7]; see EVALUATION OF METHOD

APPLICABILITY: The quantitative working range is 0.04 to 0.5 fiber/cc for a 1000-L air sample. The LOD depends on sample volume and quantity of interfering dust, and is, 0.01 fiber/cc for atmospheres free of interferences. The method gives an index of airborne fibers. It is primarily used for estimation asbestos concentrations, though PCM does not differentiate between asbestos and other fibers. Use this method in conjunction with electron microscopy (e.g. Method 7402) for assistance in identification of fibers. Fiber, ca, 0.25 μ m diameter will not be detected by this method [8]. This method may be used for other materials such as fibrous glass by using alternate counting rules (see Appendix C).

INTERFERENCES: Any other airborne fiber may interfere since all particles meeting the counting criteria are counted. Chain-like particles may appear fibrous. High levels of non-fibrous dust particles may obscure fibers in the field of view and increase the detection limit.

OTHER METHODS: This method introduces changes for improved sensitivity and reproducibility. It replaces P& CAM 239 [7.9] and NIOSH Method 7400. Revision #2 (dates 8/15/87).

FIBERS

METHOD: 7400

REAGENTS:

1. Acetone*
2. Triacetin (glycerol triacetate), reagent grade.

*SEE SPECIAL PRECAUTIONS.

EQUIPMENT:

1. Sampler: field monitor, 25 mm, three-piece cassette with ca. 50 mm electrically conductive extension cowl and cellulose ester filter, 0.45 to 1.2 μ m pore size, and backup pad.

NOTE 1: Analyze representative filters for fiber background before use. Discard the filter lot if mean is 25 fibers per 100 graticule fields. These are defined as laboratory blanks. Manufacturer-provided quality assurance checks on filter blanks are normally adequate as long as field blanks are analyzed as described below.

NOTE 2: The electrically conductive extension cowl reduces electrostatic effects. Ground the cowl when possible during sampling (10).

NOTE 3: Use 0.8 μ m pore size filters for personal sampling. The 0.45 μ m filters are recommended for sampling when performing TEM analysis on the same samples. However, their higher-pressure drop precludes their use with personal sampling pumps.

2. Sampling pump, 0.5 to 16 L/min (see step 4 for flow rate), with flexible connecting tubing.
3. Microscope, positive phase (dark) contrast, with green or blue filter, adjustable field iris, 8 to 10x eyepiece, and numerical aperture = 0.65 to 0.75.
4. Slides, glass, frosted-end, pre-cleaned, 25 x 75 mm.
5. Cover slips, 22 x 22 mm, No. 1-1/2 unless otherwise specified by microscope manufacturer.
6. Lacquer or nail polish.

7. Knife, #10 surgical steel, curved blade.
8. Tweezers.
9. Heated aluminum block for clearing filters on glass slides (see ref. [6] for specifications or see manufacturer's instructions for equivalent devices).
10. Micropipettes, 5- μ L and 100 to 500 μ L.
11. Graticule, Walton-Beckett type, 100 μ m diameter circular field (area = 0.00785 mm²) at specimen plane (type G-22). Available from PTR Optics LTD., 145 Newton Street, Accessories and Components, 850 Pasquinelli Drive, Westmont, IL 60559 (phone 312-887-7100).

NOTE: The graticule is custom-made for each microscope. See Appendix A for the custom ordering procedure).

12. HSE/NPL phase contrast test slide, Mark II. Available from PTR Optics LTD. (address above).
13. Telescope, ocular phase-ring centering.
14. Stage micrometer (0.01 mm divisions).
15. Wire, multi-stranded, 22-gauge.
16. Tape, shrink or adhesive.

***SPECIAL PRECAUTIONS:** Acetone is extremely flammable. Take precautions not to ignite it. Heating of acetone in volumes greater than 1mL must be done in a ventilated laboratory fume hood using a flameless, spark-free source.

SAMPLING:

1. Calibrate each personal sampling pump with a representative sampler in line.
2. For personal sampling, fasten sampler to the worker's lapel near the worker's mouth. Remove top cover from cowl extension (open face) and orient face down. Wrap joint between cowl and monitor body with tape to help hold the cassette together, keep the joint free of dust, and provide a marking surface to identify the cassette.
NOTE: If possible, ground the cassette to remove any surface charge, using a wire held in contact (e.g. with a hose clamp) with the conductive cowl and an earth ground such as a cold-water pipe.
3. Submit at least two field blanks (or 10% of the total samples, whichever is greater) for each set of samples. Handle field blanks in the same fashion as other samplers. Open field blank cassettes at the same time as other cassettes just prior to sampling. Store top covers and cassettes in a clean area with the top covers from the sampling cassettes during the sampling period.
4. Sample at 0.5 L/min or greater [11]. Adjust sampling flow rate, q (L/min), and time, t (min), to produce a fiber density, E , of 100 to 1300 fibers /mm² ($3.85 \cdot 10^4$ to $5 \cdot 10^5$ fibers per 25 mm filter with effective collection area $A_c = 385$ mm²) for optimum accuracy. These variables are related to the action level (one half the current standards), L (fibers/cc), of the

fibrous aerosol being sampled by:

$$\frac{t = A_c \cdot E}{Q \cdot L \cdot 10^3}, \text{ min}$$

NOTE 1: The purpose of adjusting sampling times is to obtain optimum fiber loading on the filter. A sampling rate of 1 to 4 L/min for 8 hrs. is appropriate in atmospheres containing ca. 0.1 fiber/cc in the absence of significant amounts of non-asbestos countable samples. In such cases take short, consecutive samples and average the results over the total collection time. For documenting episodic exposures, use atmospheres, where targeted fiber concentrations are much less than 0.1-fiber/cc use larger sample volumes (3,000 to 10,000 L) to achieve quantifiable loadings. Take care, however, not to overload the filter with background dust. If 50% of the filter surface is covered with particles, the filter may be too overloaded to count and will bias the measured fiber concentration. ≥

NOTE 2: OSHA regulations specify a maximum sampling rate of 2.5 L/min [1].

NOTE 3: OSHA regulates specify a minimum sampling volume of 48 L for an excursion measurement [1].

5. At the end of sampling, replace top cover and end plugs.
6. Ship samples with conductive cowl attached in a rigid container with packing material to prevent jostling or damage.

NOTE: Do not use untreated polystyrene foam in shipping container because electrostatic forces may cause fiber loss from sample filter.

SAMPLE PREPARATION:

NOTE 1: The object is to produce samples with a smooth (non-grainy) background in a medium with refractive index of 1.46. This method collapses the filter for easier focusing and produces relatively permanent mounts, which are useful for quality control and inter-laboratory comparison. The aluminum “hot block” or similar flash vaporization techniques may be used outside the laboratory [6]. Other mounting techniques meeting the above criteria may also be used (e.g. the laboratory fume hood procedure for generating acetone vapor as described in Method 7400 – revision of 5/15/85, or the non-permanent field mounting technique used in P&CAM 239 (3,7,9, 12). A videotape of the mounting procedure is available from the NIOSH Publication Office [13]

NOTE 2: Excessive water in the acetone may slow the clearing of the filters, causing material to be washed off the surface of the filter. Also, filters that have been exposed to high humidity's prior to clearing may have a grainy background.

7. Ensure that the glass slides and cover slips are free of dust and fibers.

8. Adjust the rheostat to heat the “hot block” to ca. 70 °C [6].

NOTE: If the “hot block” is not used in a fume hood, it must rest on a ceramic plate and be isolated from any surface susceptible to heat damage.

9. Mount a wedge cut from the sample filter on a clean glass slide.

- a. Cut wedges of ca. 25% of the filter area with curved-blade knife using a rocking motion to prevent tearing. Place wedge, dust side up, on slide.

NOTE: Static electricity will usually keep the wedge on the slide.

- b. Insert slide with wedge into the receiving slot at the base of “hot block”. Immediately place tip of a micropipette containing ca. 250 uL acetone (use the minimum volume needed to consistently clear the filter sections) into the inlet port of the PTFE-cap on top of the “hot block” and inject the acetone into the vaporization chamber with a slow, steady pressure on the plunger button while holding pipet firmly in place. After waiting 3 to 5 seconds for the filter to clear, remove pipet and slide from their ports.

CAUTION: Although the volume of acetone used is small, use safety precautions. Work in a well-ventilated area (e.g. laboratory fume hood). Take care not to ignite the acetone. Continuous, frequent use of this device in an unventilated space may produce explosive acetone vapor concentrations.

- c. Using the 5-uL micropipette, immediately place 3.0 to 3.5 uL triacetin on the wedge. Gently lower a clean cover slip onto the wedge at a slight angle to reduce bubble formation. Avoid excess pressure and movement of the cover glass.

NOTE: If too many bubbles form or the amount of triacetin is insufficient, the cover slip may become detached within a few hours. If excessive triacetin remains at the edge of the filter under the cover slip, fiber migration may occur.

- d. Glue the edges of the cover slip to the slide using lacquer or nail polish [14] counting may proceed immediately after clearing and mounting are completed.

NOTE: If clearing is slow, warm the slide on a hotplate (surface temperature 50 °C) for up to 15 minutes to hasten clearing. Heat carefully to prevent gas bubble formation.

CALIBRATION AND QUALITY CONTROL:

10. Microscope adjustments. Follow the manufacturer’s instructions. At least once daily use the telescope ocular (or Bertrand lens, for some microscopes) supplied by the manufacturer to ensure that the phase rings (annular diaphragm and phase-shifting elements) are concentric. With each microscope, keep a logbook in which to record the dates of calibrations and major servicing.

- a. Each time a sample is examined, do the following:

1. Adjust the light source for even illumination across the field of view at the condenser iris. Use Kohler illumination, if available. With some microscopes, the illumination may have to be set up with bright field optics rather than phase contrast optics.

2. Focus on the particulate material to be examined.
 3. Make sure that the field iris is in focus, centered on the sample, and open only enough to fully illuminate the field of view.
- b. Check the phase shift detection limit of the microscope periodically for each analyst/microscope combination:
1. Center the HSE/NPL phase contrast test slide under the phase objective
 2. Bring the blocks of grooved lines into focus in the graticule area.
NOTE: The slide contains seven blocks of grooves (ca. 20 grooves per block) in descending order of visibility. For asbestos counting the microscope optics must completely resolve the grooved lines in blocks 6 and 7 must be invisible when centered in the graticule area. Blocks 4 or 5 must be at least partially visible but may vary slightly in visibility between microscopes. A microscope, which fails to meet these requirements, has resolution either too low or too high for fiber counting.
 3. If image quality deteriorates, clean the microscope optics. If the problem persists, consult the microscope manufacturer.

11. Document the laboratory's precision for each counter for replicate fiber counts.

- a. Maintain as a part of the laboratory quality assurance program a set of reference slides to be used on a daily basis [15]. These slides should consist of filter preparations including a range of loadings and background dust levels from a variety of sources including both field and PAT samples. The Quality Assurance Officer should maintain custody of the reference slides and should supply each counter with a minimum of one reference slide per workday. Change the labels on the reference slides periodically so that the counter does not become familiar with the samples.
- b. From blind repeat counts on reference slides; estimate the laboratory intra and inter-counter s_r (step 21). Obtain separate values of relative standard deviation for each sample matrix analyzed in each of the following ranges: 5 to 20 fibers in 100 graticule fields, .20 to 50 fibers in 100 graticule fields, .50 to 100 fibers in 100 graticule fields, and 100 fibers in less than 100 graticule fields. Maintain control charts for each of these data files.
NOTE: Certain sample matrices (e.g. asbestos cement) have been shown to give poor precision [16].

12. Prepare and count field blanks along with the field samples. Report counts on each field blank.

NOTE 1: The identity of blank filters should be unknown to the counter until all counts have been completed.

NOTE 2: If a field blank yields greater than 7 fibers per 100 graticule fields, report possible contamination of the samples.

13. Perform blind recounts by the same counter on 10% of filters counted (slides relabeled by a person other than the counter). Use the following test to determine whether a pair of counts by the same counter on the same filter should be rejected

because of possible bias: Discard the sample if the absolute value of the difference between the square roots of the two counts (in fibers/mm²) exceeds 2.8 (X) s_r, where X = the average of the square roots of the two fiber counts (in fibers/mm²) and s_r = one-half the intra-counter relative standard deviation for the appropriate count range (in fibers) determined, from step 11. For more complete discussions see reference [15].

NOTE 1: Since fiber counting is the measurement of randomly placed fibers which may be described by a Poisson distribution, a square root transformation of the fiber count data will result in approximately normally distributed data [15].

NOTE 2: If a pair of counts is rejected by this test, recount the remaining samples in the set and test the new counts against the first counts. Discard all rejected paired counts. It is not necessary to use this statistic on blank counts.

14. The analyst is a critical part of this analytical procedure. Care must be taken to provide a non-stressful and comfortable environment for fiber counting. An ergonomically designed chair should be used, with the microscope eyepiece situated at a comfortable illumination level in the microscope to reduce eye fatigue. In addition, counter should take 10 to 20 minute breaks from the microscope every one or two hours to limit fatigue [17]. During these breaks, both eye and upper back/neck exercises should be performed to relieve strain.

15. All laboratories engaged in asbestos counting should participate in a proficiency-testing program such as the AIHA/NIOSH Proficiency Analytical Testing (PAT) Program or the AIHA Asbestos Analyst Registry and routinely exchange field samples with other laboratories to compare performance of counters.

NOTE: OSHA requires that each analyst performing this method take the NIOSH direct training course #582 or equivalent [1]. Instructors of equivalent courses should have attended the NIOSH #582 course at NIOSH within three years of presenting an equivalent course.

MEASUREMENT:

16. Center the slide on the stage of the calibrated microscope under the objective lens. Focus the microscope on the plane of the filter.

17. Adjust the microscope (Step 10).

NOTE: Calibration with the HSE/NPL test slide determines the minimum detectable fiber diameter (ca. 0.25 μm) [8]

18. Counting rules: (same as P&CAM 239 rules [3,7 9]; see APPENDIX 8).

- a. Count only fibers longer than .5 μm . Measure length of curved fibers along the curve.
- b. Count only fibers with a length to width ratio equal to or greater than 3:1.
- c. For fibers which cross the boundary of the graticule field:
 1. Count any fiber longer than 5 μm, which lies entirely within the graticule area.

2. Count as $\frac{1}{2}$ fiber any fiber with only one end lying within the graticule area, provided that the fiber meets the criteria of rules a and b above.
 3. Do not count any fiber, which crosses the graticule boundary more than once.
 4. Reject and do not count all other fibers.
 - d. Count bundles of fibers as one fiber unless individual fibers can be identified by observing both ends of a fiber.
 - e. Count enough graticule fields to yield 100 fibers. Count a minimum of 20 fields. Stop at 100 graticule fields regardless of count.
19. Start counting from the tip of the filter wedge and progress along a radial line to the outer edge. Shift up or down on the filter, and continue in the reverse direction. Select graticule fields randomly by looking away from the eyepiece briefly while advancing the mechanical stage. Ensure that, as a minimum, each analysis covers one radial line from the filter center to the outer edge of the filter. When an agglomerate covers ca. $\frac{1}{6}$ or more of the graticule field, reject the graticule field and select another. Do not report rejected graticule fields in the total number counted.

NOTE 1: When counting a graticule field, continuously scan a range of faocal planes by moving the fine focus knob to detect very fine fibers which have become embedded in the filter. The small diameter fibers will be very faint but are an important contribution to the total count. A minimum counting time of 15 seconds per field is appropriate for accurate counting.

NOTE 2: This method does not allow for differentiation of fibers based on morphology. Although some experienced counters are capable of selectively counting only fibers, which appear to be asbestiform, there is presently no accepted method for ensuring uniformity of judgment between laboratories. It is, therefore, incumbent upon all laboratories using this method to report total fiber counts. If serious contamination from non-asbestos fibers occurs in samples, other techniques such as transmission electron microscopy must be used to identify the asbestos fiber fraction present in the sample (see NIOSH Method 7402). In some cases (i.e., for fibers with diameters $.1 \mu\text{m}$), polarized light microscopy techniques may be used to identify and eliminate interfering non-crystalline fibers [18].

NOTE 3: Under certain conditions, electrostatic charge may affect the sampling of fibers. These electrostatic effects are most likely to occur when the relative humidity is low (below 20%), and when sampling is performed near the source of aerosol. The result is that deposition of fibers on the filter is reduced, especially near the edge of the filter. If such a pattern is noted during fiber counting, choose fields as close to the center of the filter as possible. [10].

CALCULATIONS AND REPORTING OF RESULTS:

20. Calculate and report fiber density on the filter, E (fibers/ mm^2), by dividing the average fiber count per graticule field, f/n_f , minus the mean field blank count per graticule field, B/n_b , by the graticule field area, A_f (approx. 0.00785 mm^2):

$$E = \frac{(\bar{f} - B)}{A_F} \text{ fibers/mm}^2$$

NOTE: Fiber counts above 1300 fibers/mm² and fiber counts from samples with >50% of filter area covered with particulate should be reported as “uncountable” or “probably biased.”

21. Calculate and report the concentration, C (fibers/cc), of fibers in the air volume sampled, V (L), using the effective collection area of the filter, A_c (approx. 385 mm² for a 25-mm filter):

$$C = \frac{(E)(A_c)}{V \cdot 10^3}$$

NOTE: Periodically check and adjust the value of A_c, if necessary.

22. Report intralaboratory and interlaboratory relative standard deviations (Step 11) with each set of results.

NOTE: Precision depends on the total number of fibers counted [7,10]. Relative standard deviation is documented in references [7,18,19,20] for fiber counts up to 100 fibers in 100 graticule fields. Comparability of interlaboratory results is discussed below. As a first approximation, use 213% above and 49% below the count as the upper and lower confidence limits for fiber counts greater than 20 (Fig. 1).

EVALUATION OF METHOD:

- A. This method is a revision of P&CAM 239 [3, 7, 9]. A summary of the revisions is as follows:

1. Sampling:

The change from a 37-mm to a 250mm filter improves sensitivity for similar air volumes. The change in flow rates allows for 2-m³ full-shift samples to be taken, providing that the filter is not overloaded with non-fibrous particulates. The collection of efficiency of the sampler is not a function of flow rate in the range 0.5 to 16L/min [11].

2. Sample Preparation Technique:

The acetone vapor-triacetin preparation technique is a faster, more permanent mounting technique than the dimethyl phthalate/diethyl oxalate method of P&CAM 239 [6,8,9]. The aluminum “hot block” technique minimizes the amount of acetone

needed to prepare each sample.

3. Measurement:

- a. The Walton-Beckett graticule standardizes the area observed [21, 22, 23].
- b. The HSE/NPL test slide standardizes microscope optics for sensitivity to fiber diameter [8, 21].
- c. Because of past inaccuracies associated with low fiber counts, the minimum recommended loading has been increased to 100-fibers/mm² filter area (80 fibers total count). Lower levels generally result in an overestimate of the fiber count when compared to results in the recommended analytical range [25]. The recommended loadings should yield intracounter s_r in the range of 0.10 to 0.17 [7, 24, 26].

B. Interlaboratory Comparability:

An international collaborative study involved 16 laboratories using prepared slides from the asbestos cement, milling, mining, textile, and friction material industries [16]. The relative standard deviations (s_r) varied with sample type and laboratory. The ranges were:

	s_r		
	<u>Intralaboratory</u>	<u>Interlaboratory</u>	<u>Overall</u>
AIA (NIOSH Rules)	0.12 to 0.40	0.27 to 0.85	0.46

* Under AIA rules, only fibers having a diameter less than 3_{μm} are counted and fibers attached to particles larger than 3_{μm} are not counted. NIOSH rules are otherwise similar to the AIA rules.

A NIOSH study was conducted using field samples of asbestos [24]. This study indicated intralaboratory s_r in the range 0.17 to 0.25 and an interlaboratory s_r of 0.45. This agrees well with other recent studies [16, 19, 21].

At this time, there is no independent means for assessing the overall accuracy of this method. One measure of reliability is to estimate how well the count for a single sample agrees with the mean count from a large number of laboratories. The following discussion indicates how this estimation can be carried out based on measurements of the interlaboratory variability, as precision and to measured intra- and interlaboratory s_r . (**NOTE:** The following discussion does not include bias estimated and should not be taken to indicate that lightly loaded samples are as accurate as properly loaded ones).

Theoretically, the process of counting randomly distributed (Poisson) fibers on a filter surface will give a s_r that depends on the number, N, of fibers counted:

$$s_r = 1/(N)^{1/2} \tag{1}$$

Thus s_r is 0.1 for 100 fibers and 0.32 for 10 fibers counted. The actual s_r found in a number

of studies is greater than these theoretical numbers [16, 19, 20, 21].

An additional component of variability comes primarily from subjective interlaboratory differences. In a study of ten counters in a continuing sample exchange program, Ogden [18] found this subjective component of intralaboratory s_r to be approximately 0.2 and estimated the overall s_r by the term:

$$\frac{N + (0.2 \cdot N)^2}{N} \quad (2)$$

Ogden found that the 90% confidence interval of the individual intralaboratory counts in relation to the means were $+2s_r$ and $-1.5s_r$. In this program, one sample out of ten was a quality control sample. For laboratories not engaged in an intensive quality assurance program, the subjective component of variability can be higher.

In a study of field sample results in 46 laboratories, the Asbestos Information Association also found that the variability had both a constant component and one that depended on the fiber count [21]. These results gave a subjective interlaboratory component of s_r (on the same bases as Ogden's) for field samples of ca. 0.45. A similar value was obtained for 12 laboratories analyzing a set of 24 field samples [24]. This value falls slightly above the range of s_r (0.25 to 0.42 for 1984-85) found for 80 reference laboratories in the NIOSH Proficiency Analytical Testing (PAT) program for laboratory-generated samples [20].

A number of factors influence for a given laboratory, such as that laboratory's actual counting performance and the type of samples being analyzed. In the absence of other information, such as from an interlaboratory quality assurance program using field samples, the value for the subjective component of variability is estimated a 0.45. It is hoped that laboratories will carry out the recommended interlaboratory quality assurance programs to improve their performance and thus reduce the s_r .

The above relative standard deviations apply when the population mean has been determined. It is more useful, however, for laboratories to estimate the 90% confidence interval on the mean count from a single sample fiber count (fiber 1). These curves assume similar shapes of the count distribution for interlaboratory and intralaboratory results [19].

For example, If a sample yields a count of 24 fibers, Figure 1 indicates that the mean inter-laboratory count will fall within the range of 227% above and 52% below that value of 90% of the time. We can apply these percentages directly to the air concentrations as well. If, for instance, this same (24 fibers counted) represented a 500-L volume, then the measured concentration is 0.02 fibers/mL (assuming 100 fields counted, 25-mm filter, 0.00785_{mm}^2 field counting area). If this same sample were counted by a group of laboratories, these are a 90% probability that the mean would fall between 0.01 and 0.08 fiber/mL. These limits should be reported in any comparison of results between laboratories.

Note that the s_r of 0.45 used to derive Figure 1 is used as an estimate for a random group of laboratories. If several laboratories belonging to a quality assurance group can show that their interlaboratory s_r is smaller, then it is more correct to use that smaller s_r . However, the estimated s_r of 0.45 is to be used in the absence of such information. Note also that it has

been found that s_r can be higher for certain types of samples, such as asbestos cement [16].

Quite often the estimated airborne concentration from an asbestos analysis is used to compare to a regulatory standard. For instance, if one is trying to show compliance with an 0.5 fiber/mL standard using a single sample on which 100 fibers have been counted, then figure 1 indicates that the 0.5 fiber/mL standards must be 213% higher than the measured air concentration. This indicates that if one measures a fiber concentration of 0.16 fiber/mL (100 fibers counted), then the mean fiber count by a group of laboratories (of which the compliance laboratory might be one) has a 95% chance of being less than 0.5 fibers/mL; i.e., $0.6 + 2.13 \times 0.16 = 0.5$.

If can be seen from Figure 1 that the Poisson component of the variability is not very important unless the number of fibers counted is small. Therefore, a further approximation is to simply use +213% and -49% as the upper and lower confidence values of the mean for a 100-fiber count.

**90% CONFIDENCE INTERVAL ON MEAN COUNT
(SUBJECTIVE COMPONENT (0.45) + POISSON COMPONENT)**

INSERT CHART HERE

The curves in Figure 1 are defined by the following equations

(insert formulas)

where s_r = subjective inter-laboratory relative standard deviation, which is close to the total inter-laboratory s_r when approximately 100 fibers are counted.

X = total fibers counted on sample

LCL = lower 95% confidence limit

UCL = upper 95% confidence limit

Note that the range between these two limits represents 90% of the total range.

REFERENCES:

- [1] Occupational Safety and Health Administration, U.S. Department of Labor, Occupational Exposure to Asbestos, Tremolite, Anthophyllite, and Actinolite Asbestos; Final Rules, 29 CFR Part 1910. 1001 Amended June 20, 1986; Sept 14, 1988. Final Rules 29 CFR 1926. 58 Amended Sept 14, 1988.
- [2] Mine Safety and Health Administration, U.S. Department of Commerce, Exposure Limits for Airborne Contaminants; Part 56.001 Amended July 1, 1988.
- [3] Revised Recommended Asbestos Standard, U.S. Department of Health, Education,

and Welfare, Publ. (NIOSH) 77-169 (1976); as amended in NIOSH statement at OSHA Public Hearing, June 21, 1984.

- [4] Criteria for a Recommended Standard...Occupational Exposure to Fibrous Glass, U.S. Department of Health, Education, and Welfare, Publ. (NIOSH) 77-152 (1977).
- [5] American Conference of Governmental Industrial Hygienist. "Threshold Limit Values and Biological Exposure Indices for 1988-1989," ACGIH (1988).
- [6] Baron, P.A. and G.C. Pickford. "An Asbestos Sample Filter Clearing Procedure," Appl. Ind. Hyg. 1:169-171, 199 (1986).
- [7] Leidel, N.A., S.G. Bayer, R.D. Zumwalde, and K.A. Busch. USPHS/NIOSH Membrane Filter Method for Evaluating Airborne Asbestos Fibers, U.S. Department of Health, Education, and Welfare, Publ. (NIOSH) 79-127 (1979).
- [8] Rooker, S.J., N.P. Vaughn, and J.M. LeGuen. "On the Visibility of Fibers by Phase Contrast Microscopy," Amer. Ind. Hyg. Assoc. J., 43, 505-515 (1982).
- [9] NIOSH Manual of Analytical Methods, 2nd ed., Vol. 1., P&CAM 239, U.S. Department of Health, Education, and Welfare Pub. (NIOSH) 11-157-A (1977).
- [10] Baron, P. and G. Deye, "Electrostatic Effects in Asbestos Sampling," Parts I and II Am. Ind. Hyg. Assoc. J. (submitted for publication) (1989).
- [11] Johnston, A.M., A.D. Jones, and J.H. Vincent. "The Influence of External Aerodynamic Factors on the Measurement of the Airborne Concentration of Asbestos Fibers by the membrane Filter Method," Ann. Occup. Hyg., 25, 309-316 (1982).
- [12] Jankovic, J.T., W. Jones, and J. Clere. "Field Techniques for Cleaning Cellulose Ester Filters Used in Asbestos Sampling," Appl. Ind. Hyg., 1:145-147 (1986).
- [13] Sinclair, R.C. "Filter Mounting Procedure," NIOSH Publication Videotape No. 194 (1984 [updated 1986]).
- [14] Asbestos International Association, AIA Health and Safety Recommended Technical Method #1 (RTMI). "Airborne Asbestos Fiber Concentrations at Workplaces by Light Microscopy" (Membrane Filter Method), London (1979).
- [15] Abell, M., S. Shulman and P. Baron. The Quality of Fiber Count Data, Appl. Ind. Hyg. (in press) (1989).
- [16] Crawford, N.P., H.L. Thorpe, and W. Alexander, "A Comparison of the Effects of Different Counting Rules and Aspect Ratios on the Level and Reproducibility of Asbestos Fiber Counts, Part I: Effects on Level" (Report No TM/82/23). "Part II: Effects on Reproducibility" (Report No. TM/82/84). Institute of Occupational

Medicine, Edinburgh, Scotland (December, 1982).

- [17] "Potential Health Hazards of Video Display Terminals, " NIOSH Research Report, June 1981.
- [18] McCrone, W. L. McCrone and J. Delly, "Polarized Light Microscopy," Ann Arbor Science (1978).
- [19] Ogden, T.L. "The Reproducibility of Fiber Counts, " Health and Safety Executive Research Paper 18 (1982).
- [20] Schlecht, P.C. and S.A. Schulman. "Performance of Asbestos Fiber Counting Laboratories in the NIOSH Proficiency Analytical Testing (PAT) Program, " AM. Ind. Hyg. Assoc. J., 47, 259-266 (1986).
- [21] "A Study of the Empirical Precision of Airborne Asbestos Concentration Measurements in the workplace by the Membrane Filter Method," Air Monitoring Committee Report, Asbestos Information Association, Arlington, VA (June, 1963).
- [22] Chatfield, E. J. Measurement of Asbestos fiber Concentrations in Workplace Atmospheres, Royal Commission on Matters of Health and Safety Arising from the Use of Asbestos in Ontario, Study No. 9, 180 Dundas Street West, 22nd Floor, Toronto, Ontario, Canada M5G 1Z8.
- [23] Walton, W.H. "The Nature, Hazards, and Assessment of Occupational Exposure to Airborne Asbestos Dust: A Review, " Ann. Occup. Hyg., 25, 115-247 (1982).
- [24] Baron, P.A. and S. Shulman. "Evaluation of the Magiscan Image Analyer for Asbestos fiber Counting." Am. Ind. Hyg. Assoc. J. 48:39-46.
- [25] Cherrie, J.A. Jones, and A. Johnston. "The Influence of Fiber Density on the Assessment of Fiber Concentration Using the Membrane Filter Method." Am. Ind. Hyg. Assoc. J. 47:465-74 (1986).
- [26] Taylor, D.G., P.A. Baron, S.A. Shulman and J.W. Carter. "Identification and Counting of Asbestos Fibers." Am. Ind. Hyg. Assoc. J. 45 (2), 84-88 (1984).
- [27] "Reference methods for Measuring Airborne Man-Made Mineral Fibers (MMMMF)" WHO/EURO Technical Committee for Monitoring and Evaluating Airborne MMMF, World Health Organization, Copenhagen (1985).

METHOD REVISED BY: Paul A. Baron, Ph.D.: NIOSH/DPSE

APPENDIX A: CALIBRATION OF THE WALTON-BECKETT GRATICULE

Before ordering the Walton-Beckett graticule, the following calibration must be done to obtain a counting area, (D) 100 μ m in diameter at the image plane. The diameter, d_c (mm),

of the circular counting area and the disc diameter must be specified when ordering the graticule.

1. Insert any available graticule into the eyepiece and focus so that the graticule lines are sharp and clear.
2. Set the appropriate interpupillary distance and if applicable reset the binocular head adjustment so that the magnification remains constant.
3. Install the 40 to 45X phase objective.
4. Place a stage micrometer on the microscope object stage and focus the microscope on the graduated lines.
5. Measure the magnified grid length of the graticule, L_o (μm), using the stage micrometer.
6. Remove the graticule from the microscope and measure its actual grid length, L_a (mm). This can best be accomplished by using a stage fitted with verniers.
7. Calculate the circle diameter, d_c (mm), for the Walton-Beckett graticule:

$$D_c = \frac{L_a}{L_o} \times D.$$

Example : If $l_o = 112 \mu\text{m}$, $L_a = 4.5 \text{ mm}$ and $D = 100 \mu\text{m}$, then $d_c = 4.02 \text{ mm}$.

8. Check the field diameter, D (acceptable range $100 \mu\text{m} \pm 2 \mu\text{m}$) with a stage micrometer upon receipt of the graticule for the manufacturer. Determine field area (acceptable range 0.00754 to 0.00817 mm^2).

APPENDIX B: EXAMPLES OF COUNTING RULES

Figure 2 shows a Walton-Beckett graticule as seen through the microscope. The rules will be discussed as they apply to the labeled objects in the figure.

Walton-Beckett Graticule

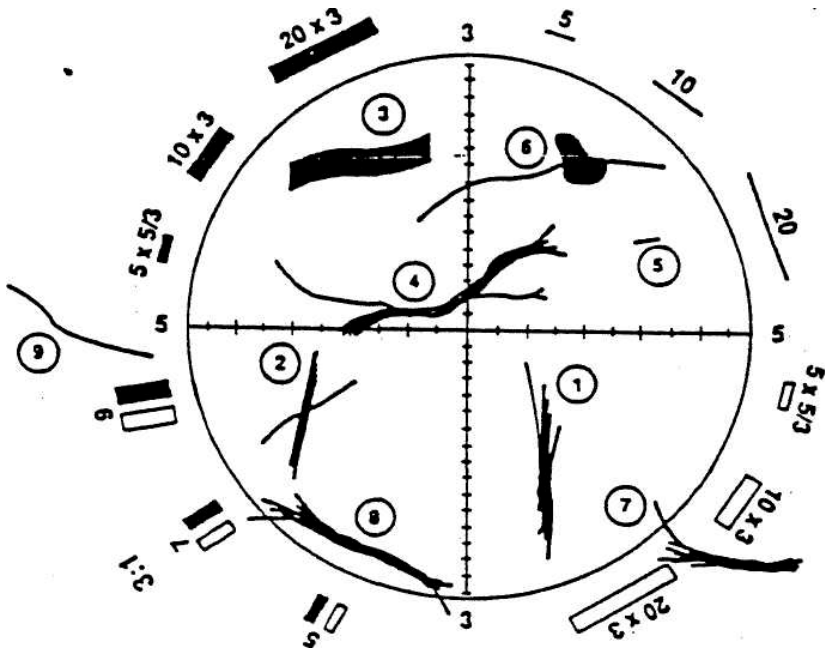

Fiber Count

Object	Count	Discussion
1	1 fiber	Optically observable asbestos fibers are actually bundles of fine fibrils. If the fibrils seem to be from the same bundle the object is counted as a single fiber. Note, however, that all objects meeting length and aspect ratio criteria are counted whether or not they appear to be asbestos.
2	2 fiber	If fibers meeting the length and aspect ratio criteria (length > 5 μm and length-to-width ratio > 3 to 1) overlap, but do not seem to be part of the same bundle, they are counted as separate fibers.
3	1 fiber	Although the object has a relatively large diameter (> 3 μm), it is counted as fiber under the rules. There is no upper limit on the fiber

diameter in the counting rules. Note that fiber width is measured at the widest compact section of the object.

4	1 fiber	Although long fine fibrils may extend from the body of a fiber, these fibrils are considered part of the fiber, these fibrils are considered part of the fiber if they seem to have originally been part of the bundle.
5	Do not count	If the object is ≤ 5 μm long, it is not counted.
6	1 fiber	A fiber partially obscured by a particle is counted as one fiber. If the fiber ends emanating from a particle do not seem to be from the same fiber and each end meets the length and aspect ratio criteria, they are counted as separate fibers.
7	$\frac{1}{2}$ fiber	A fiber which crosses into the graticule area one time is counted as $\frac{1}{2}$ fiber.
8	Do not count	Ignore fibers that cross the graticule boundary more than once.
9	Do not count	Ignore fibers that lie outside the graticule boundary.

ELECTRONIC FLOW CALIBRATORS

Description

1. These units are high accuracy electronic bubble flow-meters that provide instantaneous air flow readings and a cumulative averaging of multiple samples. These calibrators measure the flow rate of gases and report volume per unit of time.
2. The timer is capable of detecting a soap film at 80 microsecond intervals. This speed allows under steady flow conditions an accuracy of + or - 0.5% of any display reading. Repeatability is + or -0.5% of any display.
3. The range with different cells is from 1 cc/min to 30 Lpm.
4. Battery power will last 8 hours with continuous use. Charge for 16 hours. Can be operated from A/C charger.

Maintenance of Calibrator

1. Cleaning before use:

Remove the flow cell and gently flush with tap water. The acrylic flow cell can be easily scratched. Wipe with doth "only." Do not allow center tube, where sensors detect soap film to be scratched or get dirty. NEVER clean with ACETONE. Use only soap and warm water. When cleaning prior to storage, allow flow cell to air dry. If stubborn residue persists, it is possible to remove the bottom plate. Squirt a few drops of soap into the slot between base and flow cell to ease removal.

2. Leak Testing:

The system should be leak checked at 6" H₂O by connecting a manometer to the outlet boss and evacuate the inlet to 6" H₂O. No leakage should be observed.

3. Verification of Calibration:

The calibrator is factory calibrated using a standard traceable to National Institute of Standards and Technology, formerly called the National Bureau of Standards, (NBS). Attempts to verify calibrator against a glass one liter burette should be conducted at 1000 cc/min. for maximum accuracy. The calibrator is linear throughout the entire range.

Shipping/Handling

1. When transporting, especially by air, it is important that one side of the seal tube which connects the inlet and outlet boss, be removed for equalizing internal pressure within the calibrator.
2. Do not transport unit with soap solution or storage tubing in place.

Precautions/Warnings

1. Avoid the use of chemical solvents on flow cell, calibrator case and faceplate. Generally, soap and water will remove any dirt.
2. Never pressurize the flow cell at any time with more than 25 inches of water pressure.
3. Do not charge batteries for longer than 16 hours.
4. Do not leave A/C adapter plugged into calibrator when not in use as this could damage the battery supply.
5. Black close fitting covers help to reduce evaporation of soap in the flow cell when not in use.
6. Do not store flow cell for a period of one week or longer with soap. Clean and store dry.

7. The Calibrator Soap is a precisely concentrated and sterilized solution formulated to provide a dean, frictionless soap film bubble over the wide, dynamic range of the calibrator. The sterile nature of the soap is important in the prevention of residue build-up in the flow cell center tube, which could cause inaccurate readings. The use of any other soap is not recommended.

SPECIAL SAMPLING CIRCUMSTANCES

The following circumstances often require special consideration to effectively collect air samples.

Crawlspace

Final sampling must be performed inside the work area. In instances where the crawlspace floor is dirt and where abatement has been conducted to remove asbestos contamination from the dirt or from substrates adjacent to the dirt, consideration should be made to encapsulate the dirt floor. This practice locks down any residual asbestos contamination unidentified in the visual inspection, and provides a more suitable environment for clearance air sampling. As in all environments where non-asbestos particulate may present an issue in sample collection, samplers may consider lower volumes with longer sampling episodes to avoid pulling larger particulate into the filter.

Occupied Buildings

Occupied buildings present a particular challenge to the sampler. Consideration must be given to samples collected outside the work but in occupied spaces. This activity may be a source of discomfort for the occupants, which may require additional support and input from the sampler. Occupied spaces also may be a source of non-asbestos or non-project related contamination that may be collected on air samples. Occupants should be directed to avoid interference or horseplay around sampling pumps. Sampling should be conducted in areas where as little occupant disturbance may occur, but in consideration for sampling requirements for work area barrier sampling detailed in the State standard. Of course, analysis information should be made available to building occupants as soon as possible and within 48 hours as required by State requirements.

Analysis Considerations

The accuracy of sample analysis is often compromised when samples are collected in "dirty" environments and/or sampling is preformed without consideration for requirements in the NIOSH and AHERA methodologies. In the first case, the sampler must adjust his/her activities to limit non-asbestos contamination on the sample. This can be achieved by either running samples at a lower volume for a longer sample episode or by using multiple cassettes to collect a single episode.

Samplers may also consider "close-faced" sampling wherein only the inlet plug is removed, leaving the cassette cap to reduce overloading. Sampling personnel should

be familiar with the NIOSH and AHERA methodologies. At a minimum, consideration should be given to PCM analysis requirements, per the NIOSH 7400 method, specifying flow rates between .5 and 16 liters per minute with a minimum volume of 400 liters (per NIOSH - 3 "sampling"). Likewise, the AHERA method for TEM specifies sample volumes above 1200 liters.

Blanks

Blanks serve to identify pre-existing contamination on the sample media. The NIOSH 7400 method (PCM) specifies that unopened "box" blanks should represent 10% of samples submitted to the lab. Practically speaking, PCM blanks should be submitted with every sampling episode. AHERA (TEM) blank submittals must follow a specific protocol. AHERA (TEM) finals must be accompanied by three (3) blanks; one opened inside the work area for thirty (30) seconds, one opened outside the work area for thirty (30) seconds and one unopened box blank.